

Unpacking

Thank you for buying the MSI® **970A-G43 PLUS** motherboard. Check to make sure your motherboard box contains the following items. If something is missing, contact your dealer as soon as possible.

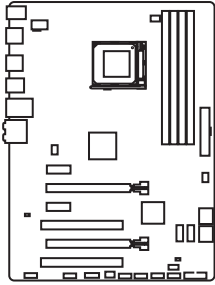

Motherboard

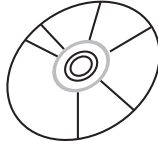

Drivers & Utilities
Disc



Motherboard User
Guide



I/O Shield

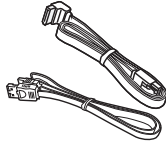

SATA Cable x2

Safety Information

- The components included in this package are prone to damage from electrostatic discharge (ESD). Please adhere to the following instructions to ensure successful computer assembly.
- Ensure that all components are securely connected. Loose connections may cause the computer to not recognize a component or fail to start.
- Hold the motherboard by the edges to avoid touching sensitive components.
- It is recommended to wear an electrostatic discharge (ESD) wrist strap when handling the motherboard to prevent electrostatic damage. If an ESD wrist strap is not available, discharge yourself of static electricity by touching another metal object before handling the motherboard.
- Store the motherboard in an electrostatic shielding container or on an anti-static pad whenever the motherboard is not installed.
- Before turning on the computer, ensure that there are no loose screws or metal components on the motherboard or anywhere within the computer case.
- Do not boot the computer before installation is completed. This could cause permanent damage to the components as well as injury to the user.
- If you need help during any installation step, please consult a certified computer technician.
- Always turn off the power supply and unplug the power cord from the power outlet before installing or removing any computer component.
- Keep this user guide for future reference.
- Keep this motherboard away from humidity.
- Make sure that your electrical outlet provides the same voltage as is indicated on the PSU, before connecting the PSU to the electrical outlet.
- Place the power cord such a way that people can not step on it. Do not place anything over the power cord.
- All cautions and warnings on the motherboard should be noted.
- If any of the following situations arises, get the motherboard checked by service personnel:
 - Liquid has penetrated into the computer.
 - The motherboard has been exposed to moisture.
 - The motherboard does not work well or you can not get it work according to user guide.
 - The motherboard has been dropped and damaged.
 - The motherboard has obvious sign of breakage.
- Do not leave this motherboard in an environment above 60°C (140°F), it may damage the motherboard.

Quick Start

Preparing Tools and Components

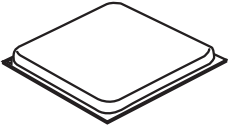

AMD® AM3/ AM3+ CPU

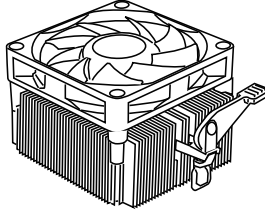

CPU Fan

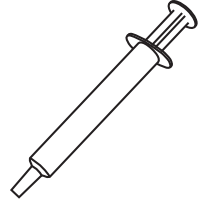

Thermal Paste

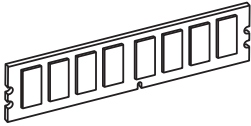

DDR3 Memory

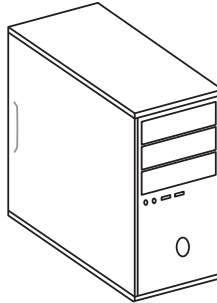

Chassis

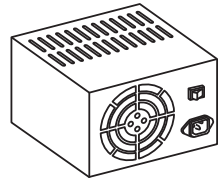

Power Supply Unit



SATA DVD Drive

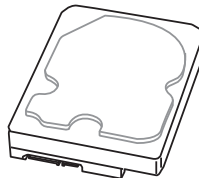

SATA Hard Disk Drive

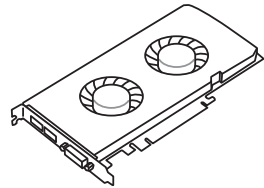

Graphics Card

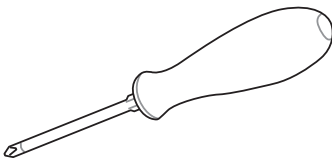

Phillips Screwdriver

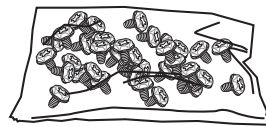

A Package of Screws

Installing a Processor

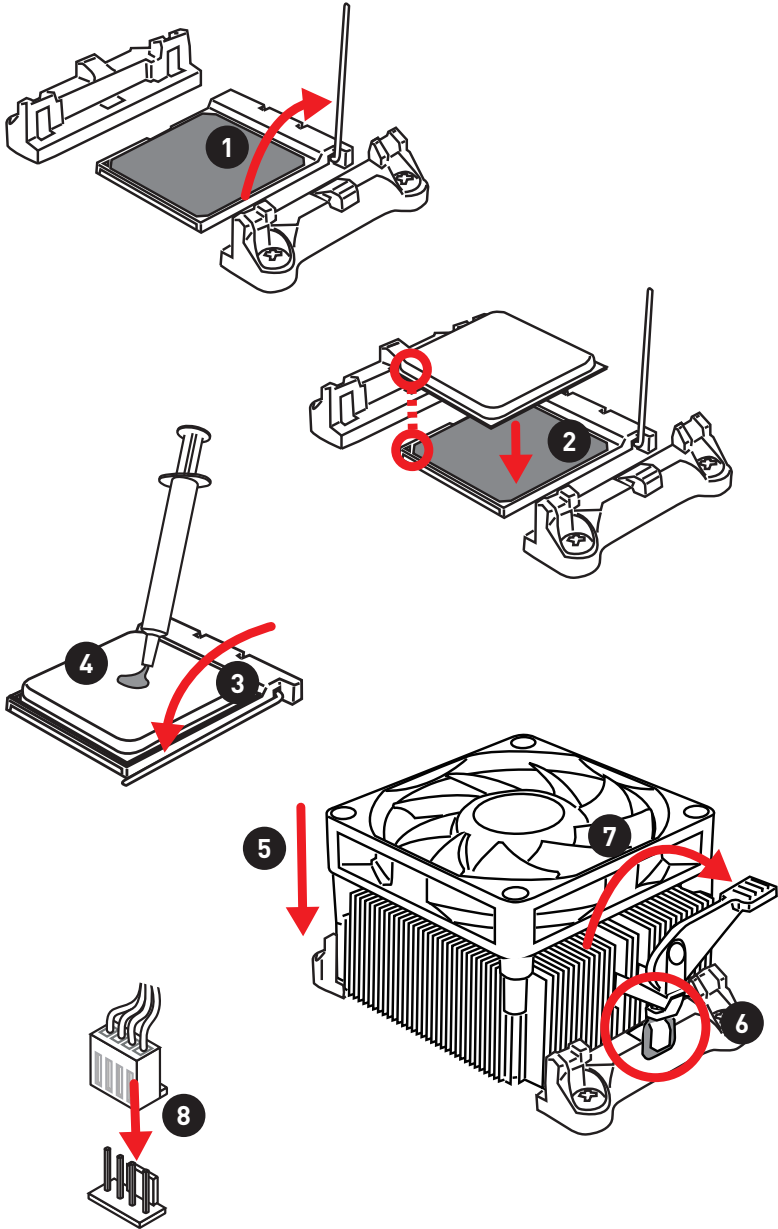

Installing DDR3 memory



<http://youtu.be/T03aDrJPYQs>

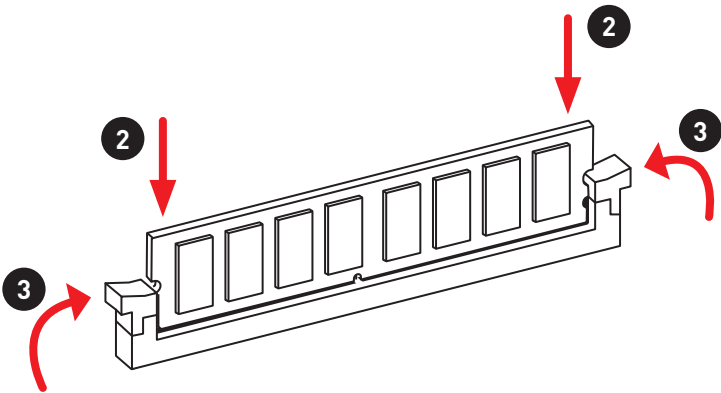
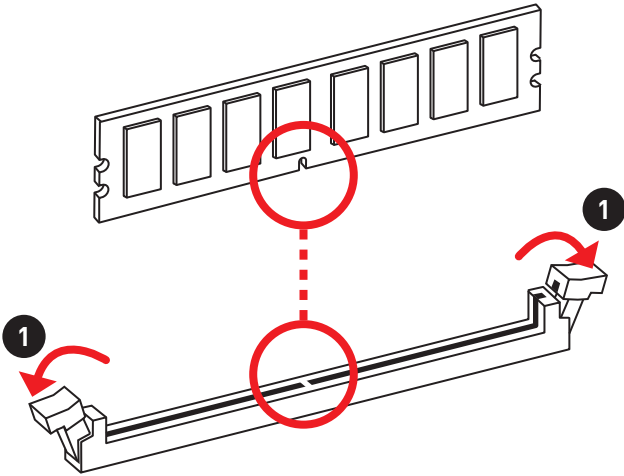

Connecting the Front Panel Header



<http://youtu.be/DPELIdVNZUI>

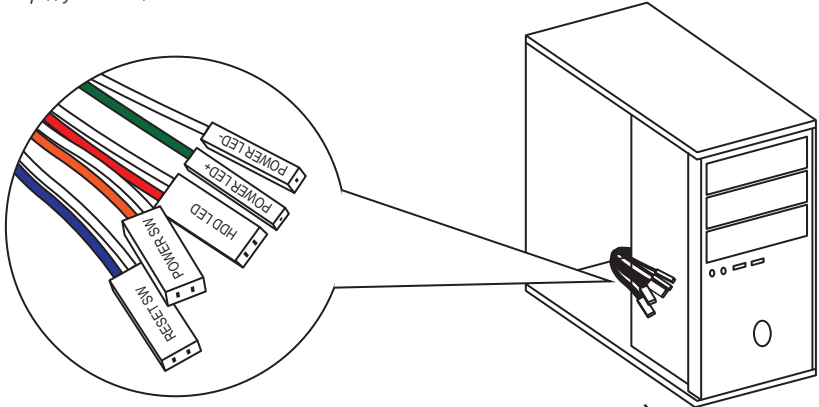

| | | | | | |
|-------------|--|---|--------------|----|--------------|
| <p>JFP1</p> | | 1 | HDD LED + | 2 | Power LED + |
| | | 3 | HDD LED - | 4 | Power LED - |
| | | 5 | Reset Switch | 6 | Power Switch |
| | | 7 | Reset Switch | 8 | Power Switch |
| | | 9 | Reserved | 10 | No Pin |

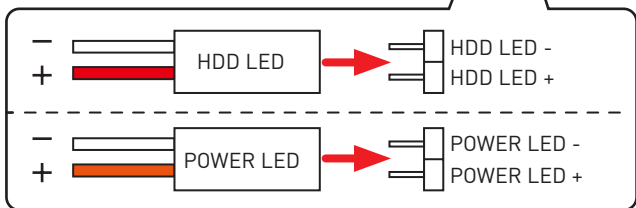
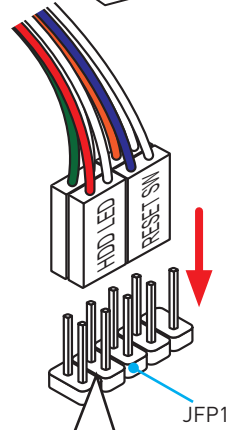

Installing the Motherboard

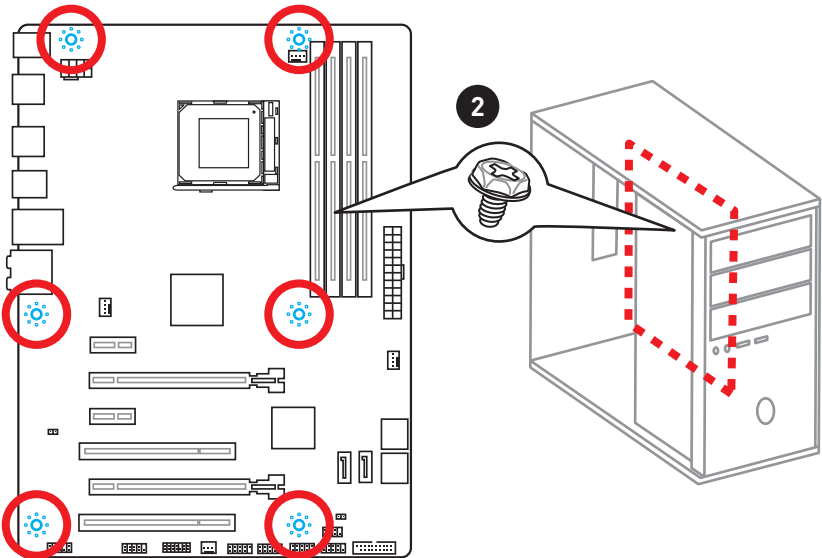
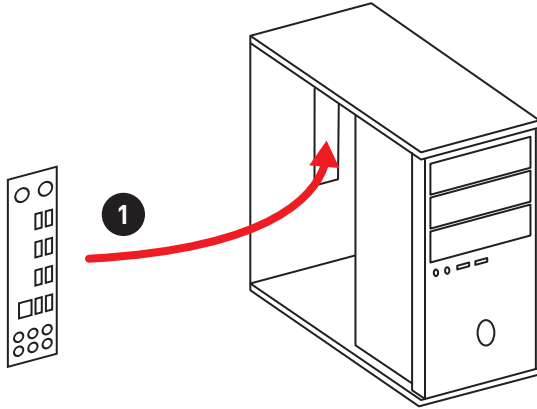

Installing SATA Drives



<http://youtu.be/RZsMpqxythc>

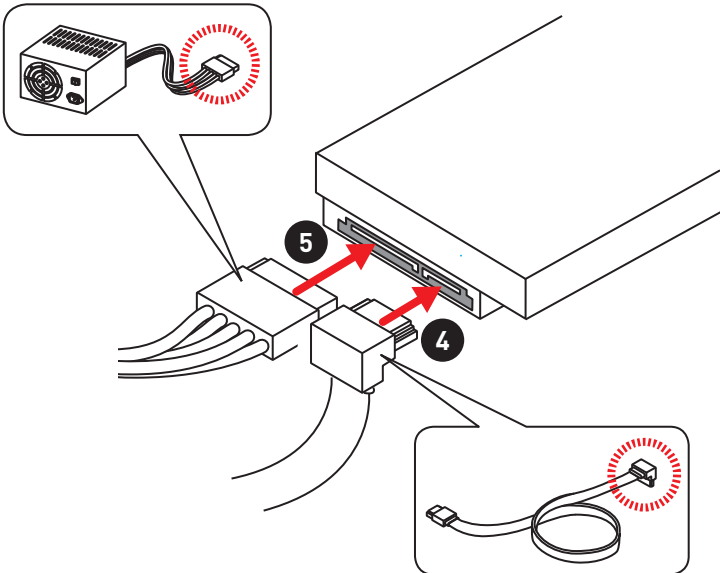
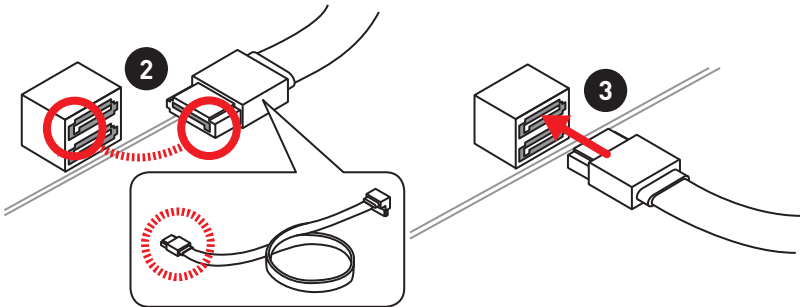
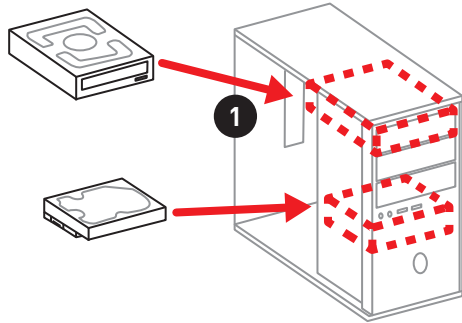

Installing a Graphics Card



http://youtu.be/mG0GZpr9w_A

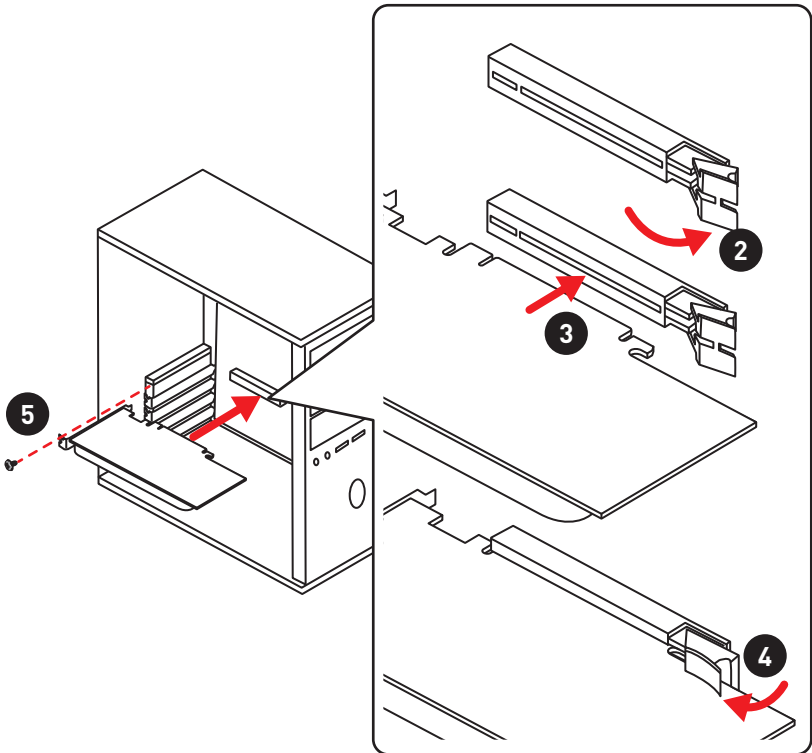
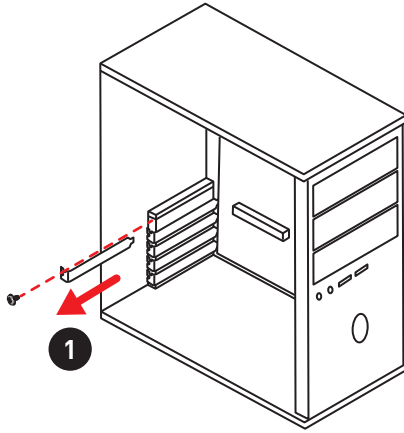

Connecting Peripheral Devices

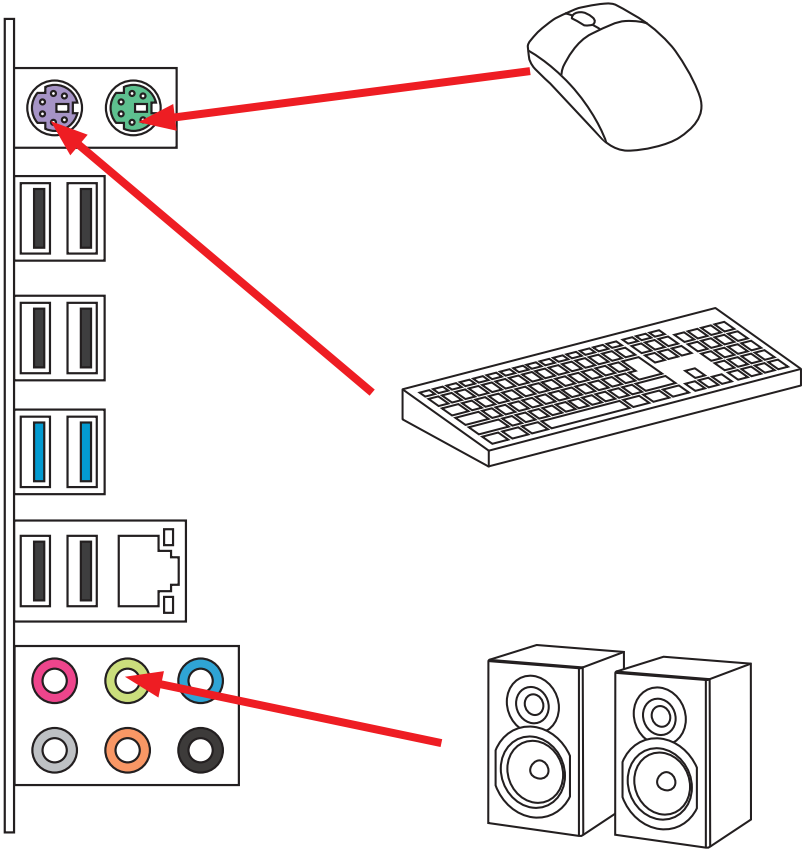

Connecting the Power Connectors



http://youtu.be/gkDYyR_83I4

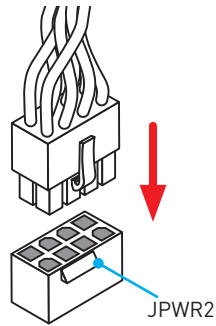
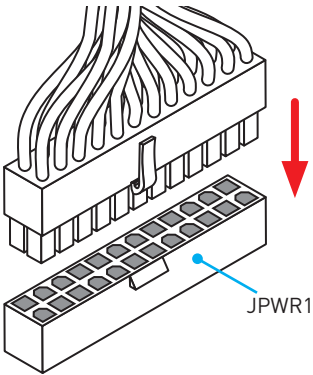
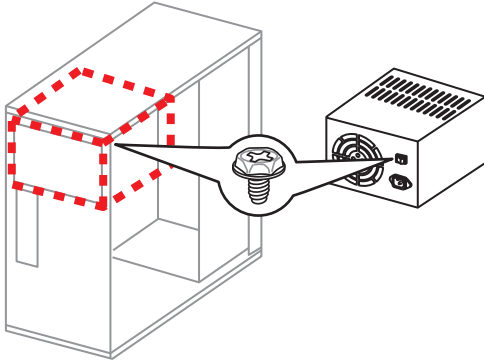

Power On

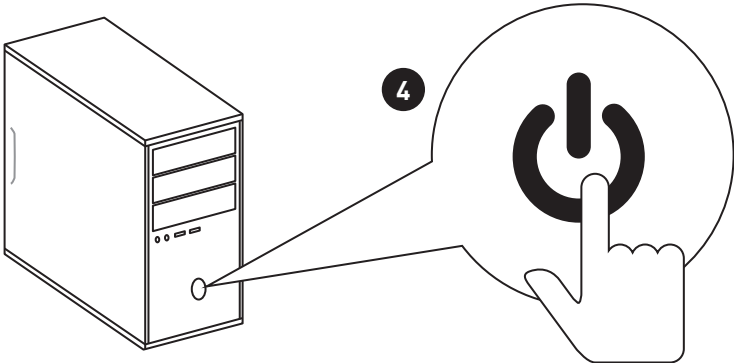
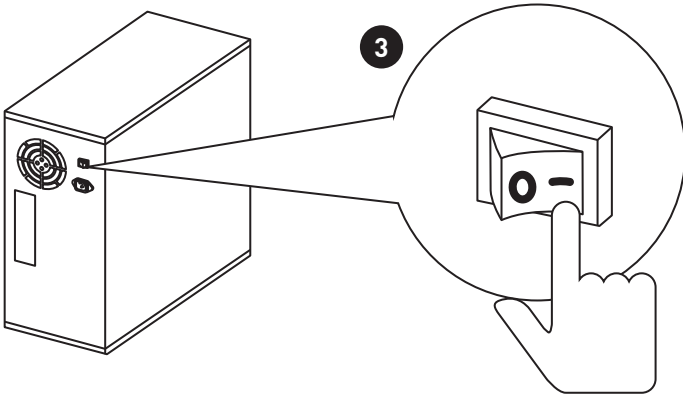
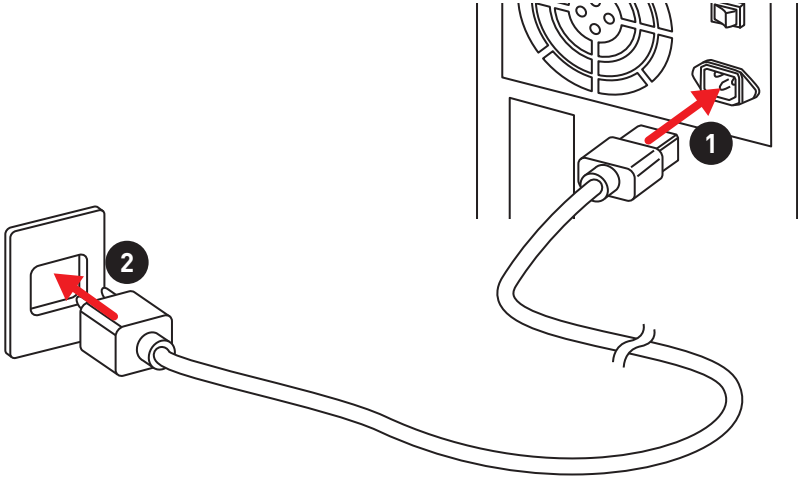

Contents

| | |
|---|-----------|
| Unpacking | 1 |
| Safety Information | 2 |
| Quick Start | 3 |
| Preparing Tools and Components | 3 |
| Installing a Processor | 4 |
| Installing DDR3 memory | 5 |
| Connecting the Front Panel Header | 6 |
| Installing the Motherboard | 7 |
| Installing SATA Drives | 8 |
| Installing a Graphics Card | 9 |
| Connecting Peripheral Devices | 10 |
| Connecting the Power Connectors | 11 |
| Power On | 12 |
| Specifications | 15 |
| Rear I/O Panel | 17 |
| LAN Port LED Status Table | 17 |
| Audio Ports Configuration | 17 |
| Realtek HD Audio Manager | 18 |
| Overview of Components | 20 |
| CPU Socket | 22 |
| DIMM Slots | 23 |
| PCI_E1~4 & PCI1~2: PCIe & PCI Expansion Slots | 24 |
| JAUD1: Front Audio Connector | 25 |
| SATA1~6: SATA 6Gb/s Connectors | 25 |
| JPWR1~2: Power Connectors | 26 |
| JUSB1~3: USB 2.0 Connectors | 27 |
| JUSB4: USB 3.1 Gen1 Connector | 27 |
| JFP1, JFP2: Front Panel Connectors | 28 |
| JTPM1: TPM Module Connector | 28 |
| JCI1: Chassis Intrusion Connector | 29 |
| JCOM1: Serial Port Connector | 29 |
| CPUFAN, SYSFAN1~3: Fan Connectors | 30 |
| JBAT1: Clear CMOS (Reset BIOS) Jumper | 31 |
| BIOS Setup | 32 |
| Entering BIOS Setup | 32 |
| Resetting BIOS | 33 |

| | |
|---|-----------|
| Updating BIOS..... | 33 |
| Overview | 34 |
| SETTINGS..... | 35 |
| Advanced..... | 35 |
| Boot..... | 40 |
| Security..... | 40 |
| Save & Exit..... | 41 |
| OC..... | 42 |
| M-FLASH | 46 |
| OC PROFILE..... | 47 |
| HARDWARE MONITOR..... | 48 |
| Software Description..... | 49 |
| Installing Drivers | 49 |
| Installing Utilities | 49 |
| COMMAND CENTER | 50 |
| LIVE UPDATE 6..... | 54 |
| NETWORK GENIE | 56 |
| RAID Configuration..... | 58 |
| Using AMD® RAID Option ROM utility..... | 58 |
| Troubleshooting | 62 |
| Regulatory Notices..... | 63 |

Specifications

| | |
|-----------------------|---|
| CPU | Supports AMD® FX™/ Phenom™/ Athlon™II/ Sempron™ processors for Socket AM3/ AM3+ |
| Chipset | AMD® 970 & SB950 Chipset |
| Memory | <ul style="list-style-type: none"> • 4x DDR3 memory slots, support up to 32GB <ul style="list-style-type: none"> ▪ Supports DDR3 1066/ 1333/ 1600/ 1866/ 2133(OC) MHz • Dual channel memory architecture |
| Expansion Slots | <ul style="list-style-type: none"> • 2x PCIe 2.0 x16 slots (support x16/ x4 mode) • 2x PCIe 2.0 x1 slots • 2x PCI slots |
| Multi-GPU | <ul style="list-style-type: none"> • Supports 2-Way AMD® CrossFire™ Technology |
| Storage | AMD® SB950 Chipset <ul style="list-style-type: none"> • 6x SATA 6Gb/s ports <ul style="list-style-type: none"> ▪ Supports RAID 0, RAID 1, RAID 5 and RAID 10 for SATA storage devices |
| USB | <ul style="list-style-type: none"> • ASMedia® ASM1143 Chipset <ul style="list-style-type: none"> ▪ 2x USB 3.1 Gen2 (SuperSpeed USB 10Gbps) ports on the back panel • ASMedia® ASM1042AE Chipset <ul style="list-style-type: none"> ▪ 2x USB 3.1 Gen1 (SuperSpeed USB) ports available through the internal USB 3.1 Gen1 connector • AMD® SB950 Chipset <ul style="list-style-type: none"> ▪ 12x USB 2.0 (High-speed USB) ports (6 ports on the back panel, 6 ports available through the internal USB connector) |
| Audio | <ul style="list-style-type: none"> • Realtek® ALC887 Codec • 7.1-Channel High Definition Audio |
| LAN | 1x Realtek® 8111E Gigabit LAN controller |
| Back Panel Connectors | <ul style="list-style-type: none"> • 1x PS/2 mouse port • 1x PS/2 keyboard port • 6x USB 2.0 ports • 2x USB 3.1 Gen2 ports • 1x LAN (RJ45) port • 6x audio jacks |

Continued on next page

Continued from previous page

| | |
|---------------------|---|
| Internal Connectors | <ul style="list-style-type: none">• 1x 24-pin ATX main power connector• 1x 8-pin ATX 12V power connector• 6x SATA 6Gb/s connectors• 3x USB 2.0 connectors (supports additional 6 USB 2.0 ports)• 1x USB 3.1 Gen1 connector (supports additional 2 USB 3.1 Gen1 ports)• 1x 4-pin CPU fan connector• 2x 4-pin system fan connectors• 1x 3-pin system fan connector• 1x Front panel audio connector• 2x Front panel connectors• 1x TPM module connector• 1x Chassis Intrusion connector• 1x Serial port connector• 1x Clear CMOS jumper |
| I/O Controller | FINTEK F71889ED Controller Chip |
| Form Factor | <ul style="list-style-type: none">• ATX Form Factor• 12 in. x 8.9 in. (30.5 cm x 22.5 cm) |
| Software | <ul style="list-style-type: none">• Drivers• COMMAND CENTER• LIVE UPDATE 6• NETWORK GENIE• FAST BOOT• SUPER CHARGER• Norton™ Security• Google Chrome™ ,Google Toolbar, Google Drive |

Rear I/O Panel

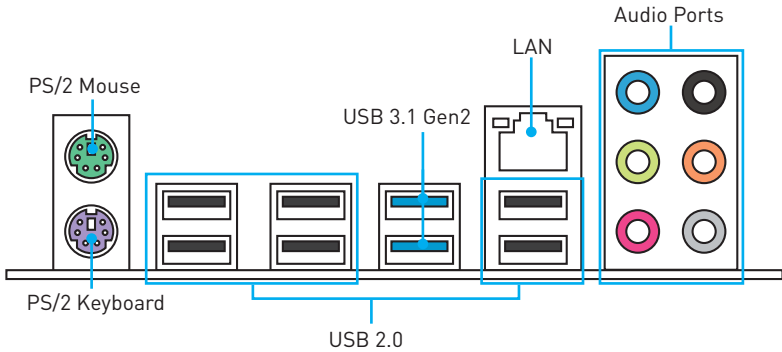

LAN Port LED Status Table

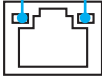
| Link/ Activity LED | |  | Speed LED | |
|--------------------|---------------|---|-----------|---------------------|
| Status | Description | | Status | Description |
| Off | No link | | Off | 10 Mbps connection |
| Yellow | Linked | | Green | 100 Mbps connection |
| Blinking | Data activity | | Orange | 1 Gbps connection |

Audio Ports Configuration

| Audio Ports | Channel | | | |
|---------------------------|---------|---|---|---|
| | 2 | 4 | 6 | 8 |
| Line In | | | | |
| Line-Out/ Front Speak Out | ● | ● | ● | ● |
| Mic In | | | | |
| Rear Speaker Out | | ● | ● | ● |
| Center/ Subwoofer Out | | | ● | ● |
| Side Speaker Out | | | | ● |

(●: connected, **Blank**: empty)

Realtek HD Audio Manager

After installing the **Realtek HD Audio** driver, the **Realtek HD Audio Manager** icon will appear in the system tray. Double click on the icon to launch.



- **Device Selection** - allows you to select a audio output source to change the related options. The **check** sign indicates the devices as default.
- **Application Enhancement** - the array of options will provide you a complete guidance of anticipated sound effect for both output and input device.
- **Main Volume** - controls the volume or balance the right/left side of the speakers that you plugged in front or rear panel by adjust the bar.
- **Profiles** - toggles between profiles.
- **Advanced Settings** - provides the mechanism to deal with 2 independent audio streams.
- **Jack Status** - depicts all render and capture devices currently connected with your computer.
- **Connector Settings** - configures the connection settings.

Auto popup dialog

When you plug into a device at an audio jack, a dialogue window will pop up asking you which device is current connected.

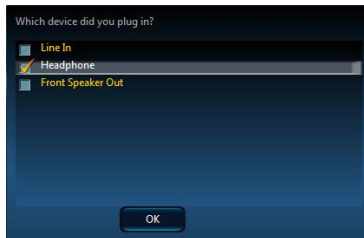

Each jack corresponds to its default setting as shown on the next page.

Audio jacks to headphone and microphone diagram

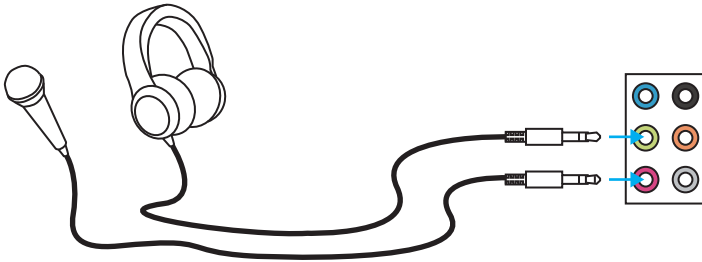

Audio jacks to stereo speakers diagram

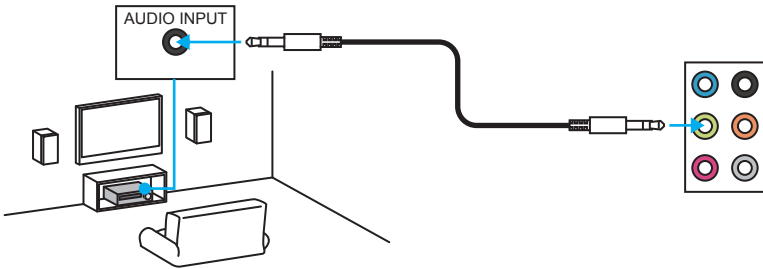

Audio jacks to 7.1-channel speakers diagram

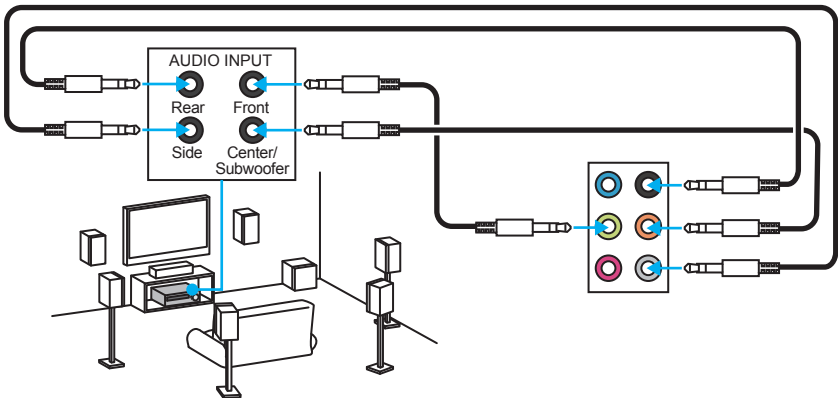

Overview of Components

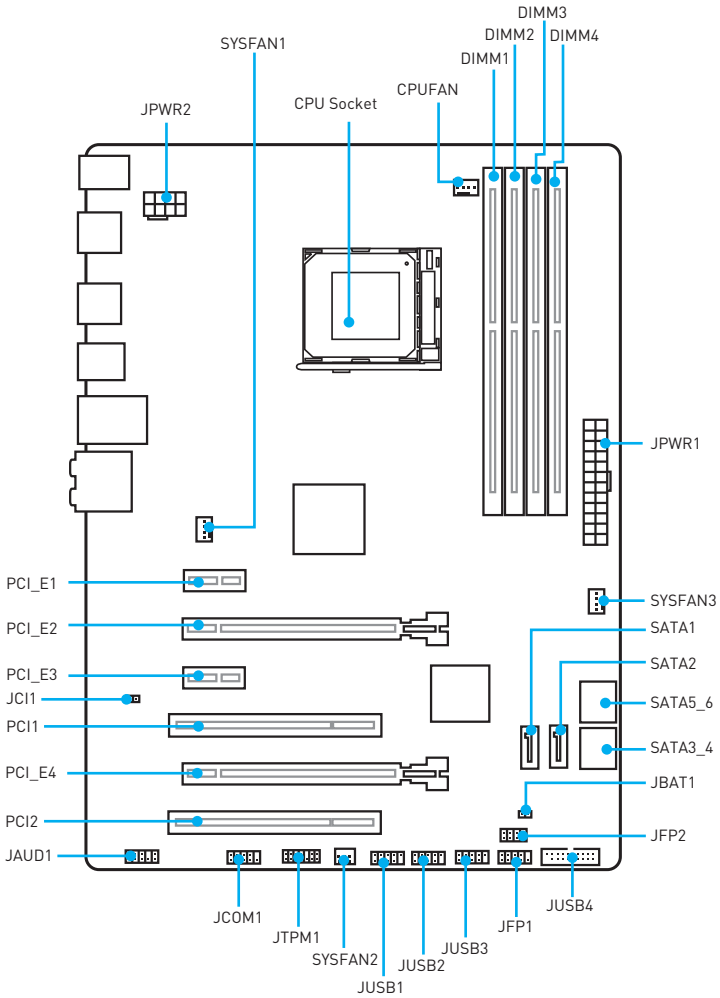

Component Contents

| Port Name | Port Type | Page |
|--------------------|--------------------------------|------|
| CPUFAN, SYSFAN1~3 | Fan Connectors | 30 |
| CPU Socket | AM3/ AM3+ CPU Socket | 22 |
| DIMM1~4 | DIMM Slots | 23 |
| JAUD1 | Front Audio Connector | 25 |
| JBAT1 | Clear CMOS (Reset BIOS) Jumper | 31 |
| JCI1 | Chassis Intrusion Connector | 29 |
| JCOM1 | Serial Port Connector | 29 |
| JFP1, JFP2 | Front Panel Connectors | 28 |
| JPWR1~2 | Power Connectors | 26 |
| JTPM1 | TPM Module Connector | 28 |
| JUSB1~3 | USB 2.0 Connectors | 27 |
| JUSB4 | USB 3.1 Gen1 Connector | 27 |
| PCI_E1~E4 & PCI1~2 | PCIe & PCI Expansion Slots | 24 |
| SATA1~6 | SATA 6Gb/s Connectors | 25 |

CPU Socket

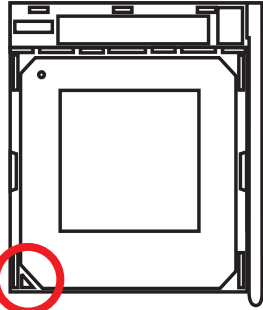
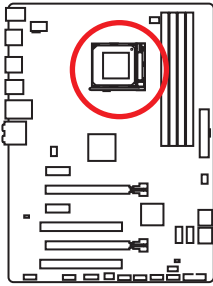

Introduction to AM3/ AM3+ CPU

The surface of the CPU has a golden triangle to assist in correctly lining up the CPU for motherboard placement. The **golden** triangle is the Pin 1 indicator.

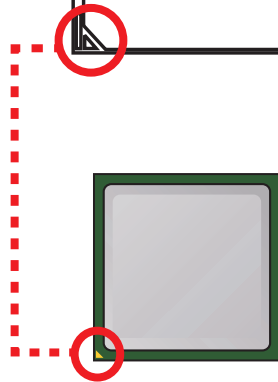

Important

- Always unplug the power cord from the power outlet before installing or removing the CPU.
- When installing a CPU, always remember to install a CPU heatsink. A CPU heatsink is necessary to prevent overheating and maintain system stability.
- Confirm that the CPU heatsink has formed a tight seal with the CPU before booting your system.
- Overheating can seriously damage the CPU and motherboard. Always make sure the cooling fans work properly to protect the CPU from overheating. Be sure to apply an even layer of thermal paste (or thermal tape) between the CPU and the heatsink to enhance heat dissipation.
- If you purchased a separate CPU and heatsink/ cooler, Please refer to the documentation in the heatsink/ cooler package for more details about installation.
- This motherboard is designed to support overclocking. Before attempting to overclock, please make sure that all other system components can tolerate overclocking. Any attempt to operate beyond product specifications is not recommended. MSI® does not guarantee the damages or risks caused by inadequate operation beyond product specifications.
- While disconnecting the safety hook from the fixed bolt. It is necessary to keep an eye on your fingers, because once the safety hook is disconnected from the fixed bolt, the fixed lever will spring back instantly.

DIMM Slots

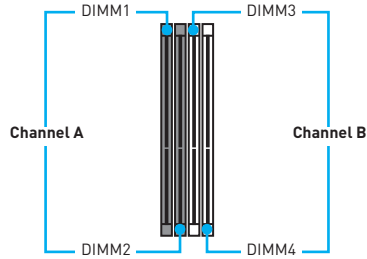
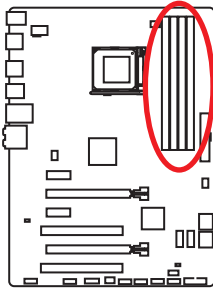

Memory module installation recommendation

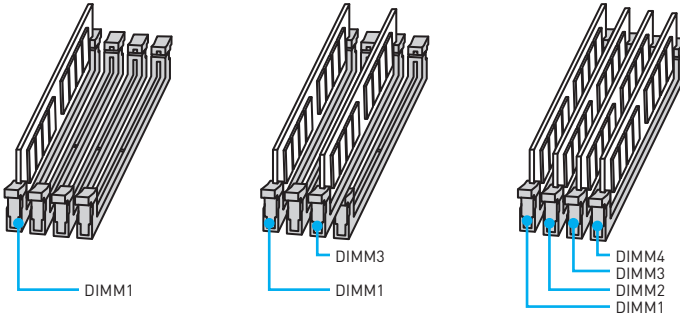

Important

- Always insert memory modules in the **DIMM1** slot first.
- Due to chipset resource usage, the available capacity of memory will be a little less than the amount of installed.
- Please note that the maximum capacity of addressable memory is 4GB or less for 32-bit Windows OS due to the memory address limitation. Therefore, we recommend that you to install 64-bit Windows OS if you want to install more than 4GB memory on the motherboard.
- Some memory may operate at a lower frequency than the marked value when overclocking due to the memory frequency operates dependent on its Serial Presence Detect (SPD).
- It is recommended to use a more efficient memory cooling system for full DIMMs installation or overclocking.
- The stability and compatibility of installed memory module depend on installed CPU and devices when overclocking.

PCI_E1~E4 & PCI1~2: PCIe & PCI Expansion Slots

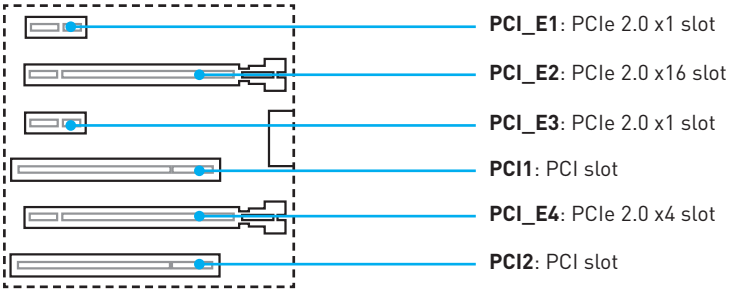

Multiple graphics cards installation recommendation

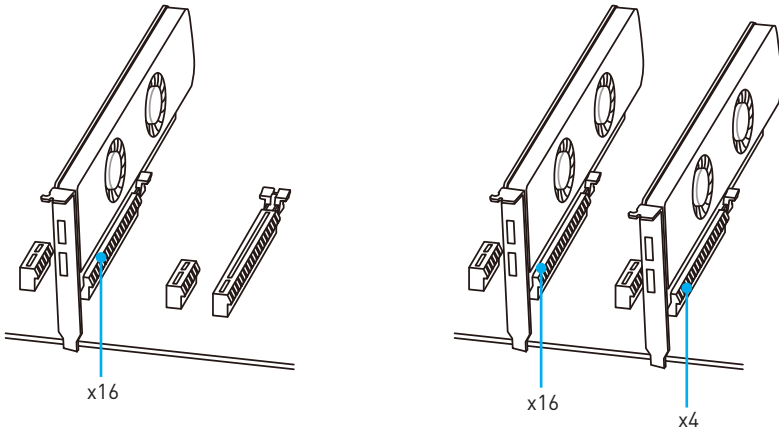

Important

- For a single PCIe x16 expansion card installation with optimum performance, using the **PCI_E2** slot is recommended.
- When adding or removing expansion cards, always turn off the power supply and unplug the power supply power cable from the power outlet. Read the expansion card's documentation to check for any necessary additional hardware or software changes.

JAUD1: Front Audio Connector

This connector allows you to connect audio jacks on the front panel.

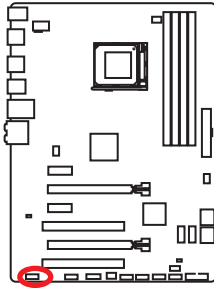

| JAUD1 Pinout | | | |
|--------------|--------------|----|----------------------|
| 2 | | 10 | |
| 1 | | 9 | |
| 1 | MIC L | 2 | Ground |
| 3 | MIC R | 4 | NC |
| 5 | Head Phone R | 6 | MIC Detection |
| 7 | SENSE_SEND | 8 | No Pin |
| 9 | Head Phone L | 10 | Head Phone Detection |

SATA1~6: SATA 6Gb/s Connectors

These connectors are SATA 6Gb/s interface ports. Each connector can connect to one SATA device.

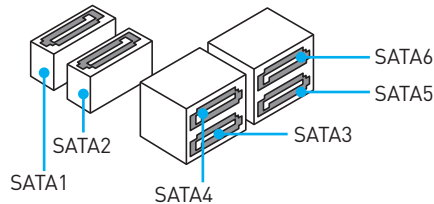
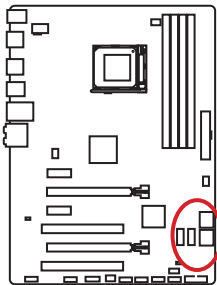



Important

- Please do not fold the SATA cable at a 90-degree angle. Data loss may result during transmission otherwise.
- SATA cable has identical plugs on either sides of the cable. However, it is recommended that the flat connector be connected to the motherboard for space saving purposes.

JPWR1~2: Power Connectors

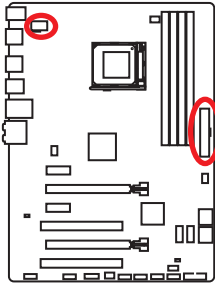
These connectors allow you to connect an ATX power supply.

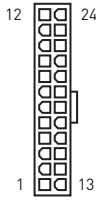

|  JPWR2 | | | |
|---|--------|---|------|
| 1 | Ground | 5 | +12V |
| 2 | Ground | 6 | +12V |
| 3 | Ground | 7 | +12V |
| 4 | Ground | 8 | +12V |

|  JPWR1 | | | | |
|---|--------|----|--------|--|
| 1 | +3.3V | 13 | +3.3V | |
| 2 | +3.3V | 14 | -12V | |
| 3 | Ground | 15 | Ground | |
| 4 | +5V | 16 | PS-ON# | |
| 5 | Ground | 17 | Ground | |
| 6 | +5V | 18 | Ground | |
| 7 | Ground | 19 | Ground | |
| 8 | PWR OK | 20 | Res | |
| 9 | 5VSB | 21 | +5V | |
| 10 | +12V | 22 | +5V | |
| 11 | +12V | 23 | +5V | |
| 12 | +3.3V | 24 | Ground | |

Important

Make sure that all the power cables are securely connected to a proper ATX power supply to ensure stable operation of the motherboard.

JUSB1~3: USB 2.0 Connectors

These connectors allow you to connect USB 2.0 ports on the front panel.

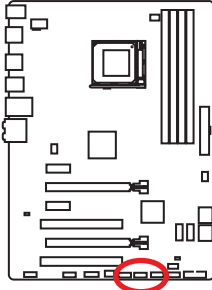

| | | | |
|---|--------|----|--------|
| | | | |
| 1 | VCC | 2 | VCC |
| 3 | USB0- | 4 | USB1- |
| 5 | USB0+ | 6 | USB1+ |
| 7 | Ground | 8 | Ground |
| 9 | No Pin | 10 | NC |

Important

- Note that the VCC and Ground pins must be connected correctly to avoid possible damage.
- In order to recharge your iPad, iPhone and iPod through USB ports, please install MSI® SUPER CHARGER utility.

JUSB4: USB 3.1 Gen1 Connector

This connector allows you to connect USB 3.1 Gen1 ports on the front panel.

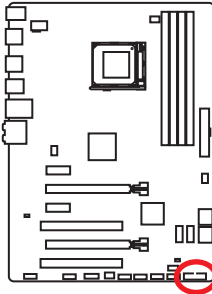

| | | | |
|----|--------------|----|--------------|
| | | | |
| 1 | Power | 11 | USB2.0+ |
| 2 | USB3_RX_DN | 12 | USB2.0- |
| 3 | USB3_RX_DP | 13 | Ground |
| 4 | Ground | 14 | USB3_TX_C_DP |
| 5 | USB3_TX_C_DN | 15 | USB3_TX_C_DN |
| 6 | USB3_TX_C_DP | 16 | Ground |
| 7 | Ground | 17 | USB3_RX_DP |
| 8 | USB2.0- | 18 | USB3_RX_DN |
| 9 | USB2.0+ | 19 | Power |
| 10 | Ground | 20 | No Pin |

Important

Note that the Power and Ground pins must be connected correctly to avoid possible damage.

JFP1, JFP2: Front Panel Connectors

These connectors connect to the switches and LEDs on the front panel.

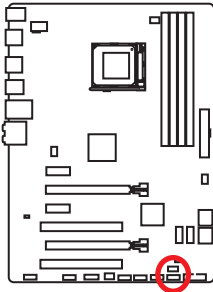

| 1 | HDD LED + | 2 | Power LED + |
|---|--------------|----|--------------|
| 3 | HDD LED - | 4 | Power LED - |
| 5 | Reset Switch | 6 | Power Switch |
| 7 | Reset Switch | 8 | Power Switch |
| 9 | Reserved | 10 | No Pin |

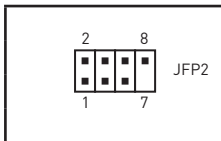

| 1 | Ground | 2 | Speaker - |
|---|-------------|---|-----------|
| 3 | Suspend LED | 4 | Buzzer + |
| 5 | Power LED | 6 | Buzzer - |
| 7 | No Pin | 8 | Speaker + |

JTPM1: TPM Module Connector

This connector is for TPM (Trusted Platform Module). Please refer to the TPM security platform manual for more details and usages.

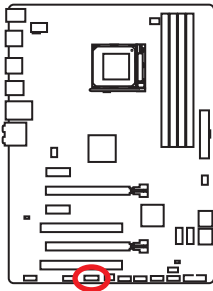

| 1 | LPC Clock | 2 | 3V Standby power |
|----|-------------------------|----|------------------|
| 3 | LPC Reset | 4 | 3.3V Power |
| 5 | LPC address & data pin0 | 6 | Serial IRQ |
| 7 | LPC address & data pin1 | 8 | 5V Power |
| 9 | LPC address & data pin2 | 10 | No Pin |
| 11 | LPC address & data pin3 | 12 | Ground |
| 13 | LPC Frame | 14 | Ground |

JCI1: Chassis Intrusion Connector

This connector allows you to connect the chassis intrusion switch cable.

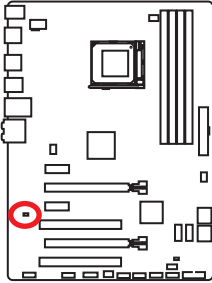

Normal
(default)



Trigger the chassis
intrusion event

Using chassis intrusion detector

1. Connect the **JCI1** connector to the chassis intrusion switch/ sensor on the chassis.
2. Close the chassis cover.
3. Go to **BIOS > SETTINGS > Security > Chassis Intrusion Configuration**.
4. Set **Chassis Intrusion** to **Enabled**.
5. Press **F10** to save and exit and then press the **Enter** key to select **Yes**.
6. Once the chassis cover is opened again, a warning message will be displayed on screen when the computer is turned on.

Resetting the chassis intrusion warning

1. Go to **BIOS > SETTINGS > Security > Chassis Intrusion Configuration**.
2. Set **Chassis Intrusion** to **Reset**.
3. Press **F10** to save and exit and then press the **Enter** key to select **Yes**.

JCOM1: Serial Port Connector

This connector allows you to connect the optional serial port with bracket.

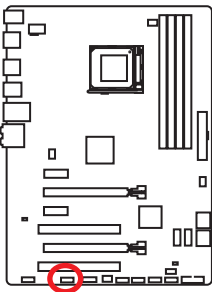

| A diagram of a 10-pin serial port connector. The pins are numbered 1 through 10. Pin 1 is at the bottom left, pin 2 is at the top left, pin 9 is at the bottom right, and pin 10 is at the top right. | | | |
|---|--------|----|--------|
| 1 | DCD | 2 | SIN |
| 3 | SOUT | 4 | DTR |
| 5 | Ground | 6 | DSR |
| 7 | RTS | 8 | CTS |
| 9 | RI | 10 | No Pin |

CPUFAN, SYSFAN1~3: Fan Connectors

Fan connectors can be classified as PWM (Pulse Width Modulation) Mode and Voltage Mode. PWM Mode fan connectors provide constant 12V output and adjust fan speed with speed control signal. Voltage Mode fan connectors control fan speed by changing voltage. Therefore, when you plug a 3-pin (Non-PWM) fan to a PWM Mode fan connector, the fan speed will be always maintained at 100%, and that could be noisy.

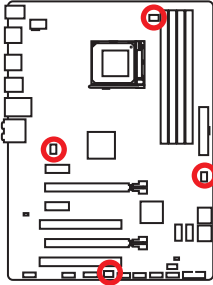

PWM Mode fan connector

| | | | |
|---|--------|---|----------------------|
|  CPUFAN | | | |
| 1 | Ground | 2 | +12V |
| 3 | Sense | 4 | Speed Control Signal |

Voltage Mode fan connector

| | | | |
|--|--------|---|------|
|  SYSFAN1/3 | | | |
| 1 | Ground | 2 | +12V |
| 3 | Sense | 4 | NC |

| | | | |
|--|--------|---|------|
|  SYSFAN2 | | | |
| 1 | Ground | 2 | +12V |
| 3 | No Use | | |

Controlling the fan speed

There are two ways to manage fan speed. One is to go to **BIOS > HARDWARE MONITOR**. The other is to use **COMMAND CENTER** application.

Both methods offer gradient points of the fan speed that allow you to adjust fan speed in relation to CPU temperature.

JBAT1: Clear CMOS (Reset BIOS) Jumper

There is CMOS memory onboard that is external powered from a battery located on the motherboard to save system configuration data. If you want to clear the system configuration, set the jumper to clear the CMOS memory.

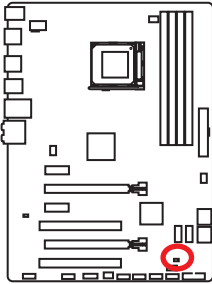

Keep Data
(default)



Clear CMOS/
Reset BIOS

Resetting BIOS to default values

1. Power off the computer and unplug the power cord.
2. Use a jumper cap to short **JBAT1** for about **5-10** seconds.
3. Remove the jumper cap from **JBAT1**.
4. Plug the power cord and power on the computer.

BIOS Setup

The default settings offer the optimal performance for system stability in normal conditions. You should **always keep the default settings** to avoid possible system damage or failure booting unless you are familiar with BIOS.

Important

- BIOS items are continuously update for better system performance. Therefore, the description may be slightly different from the latest BIOS and should be for reference only. You could also refer to the **HELP** information panel for BIOS item description.
- The pictures in this chapter are for reference only and may vary from the product you purchased.

Entering BIOS Setup

Please refer the following methods to enter BIOS setup.

- Press **Delete** key, when the **Press DEL key to enter Setup Menu, F11 to enter Boot Menu** message appears on the screen during the boot process.
- Use **MSI FAST BOOT** application. Click on **G02BIOS** button and choose **OK**. The system will reboot and enter BIOS setup directly.



Click on **G02BIOS**

Function key

| Key | Function | Key | Function |
|-----|--|-----|--|
| F1 | General Help | F4 | Enter CPU Specifications menu |
| F5 | Enter Memory-Z menu | F6 | Load optimized defaults |
| F8 | Load Overclocking Profile from USB flash drive | F9 | Save Overclocking Profile to USB flash drive |
| F10 | Save Change and Reset | F12 | Save a screenshot to a FAT/ FAT 32 USB flash drive |

Resetting BIOS

You might need to restore the default BIOS setting to solve certain problems. There are several ways to reset BIOS:

- Go to BIOS and press **F6** to load optimized defaults.
- Short the **Clear CMOS** jumper on the motherboard.



Important

Please refer to the **Clear CMOS jumper** section for resetting BIOS.

Updating BIOS

Updating BIOS with M-FLASH

Before updating:

Please download the latest BIOS file that matches your motherboard model from MSI website. And then save the BIOS file into the USB flash drive.

Updating BIOS:

1. Press Del key to enter the BIOS Setup during POST.
2. Insert the USB flash drive that contains the update file into the computer.
3. Go to **BIOS > M-Flash > Update BIOS > Select one file to update BIOS**, select a BIOS file to perform the BIOS update process.
4. After the flashing process is 100% completed, the system will reboot automatically.

Updating the BIOS with Live Update 6

Before updating:

Make sure the LAN driver is already installed and the internet connection is set properly.

Updating BIOS:

1. Install and launch MSI LIVE UPDATE 6.
2. Select **Manual scan**.
3. Check **MB BIOS** box and click on **Scan** button.
4. Select the **MB BIOS** and click on  icon to download and install the latest BIOS file.
5. Click **Next** and choose **In Windows mode**. And then click **Next** and **Start** to start updating BIOS.
6. After the flashing process is 100% completed, the system will restart automatically.

Overview

After entering BIOS, the following screen is displayed.

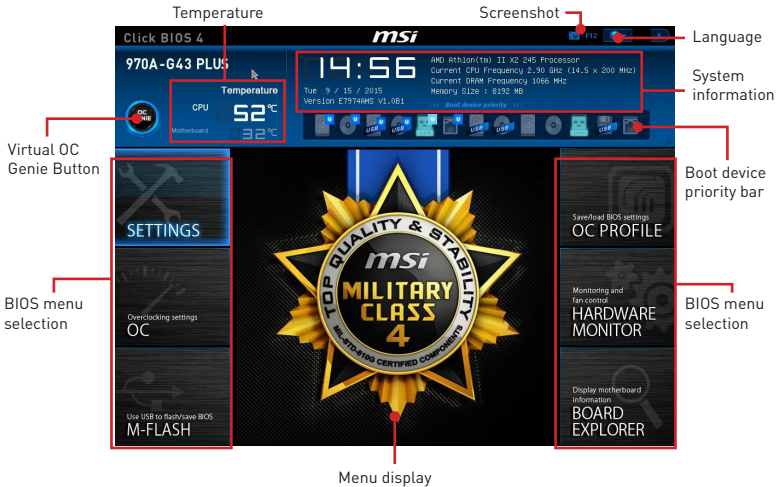

- **BIOS menu selection** - the following options are available:
 - **SETTINGS** - allows you to specify the parameters for chipset and boot devices.
 - **OC** - contains the frequency and voltage adjustments. Increasing the frequency may get better performance.
 - **M-FLASH** - provides the way to update BIOS with a USB flash drive.
 - **OC PROFILE** - allows you to manage overclocking profiles.
 - **HARDWARE MONITOR** - allows you to set the speeds of fans and monitor voltages of system.
 - **BOARD EXPLORER** - provides the information of installed devices on this motherboard.
- **Virtual OC Genie Button** - enables or disables the **OC Genie** function by clicking on this button. When enabled, this button will be light. Enabling **OC Genie** function can automatically overclock with MSI optimized overclocking profile.

Important

We recommend that you do not to make any modification in OC menu mode and do not to load defaults after enabling the OC Genie function.

- **Menu display** - provides BIOS setting items and information to be configured.
- **Boot device priority bar** - you can move the device icons to change the boot priority. The boot priority from high to low is left to right.
- **System Information** - shows the time, date, CPU name, CPU frequency, DRAM frequency, DRAM capacity and the BIOS version.
- **Language** - allows you to select the language of the BIOS setup.
- **Screenshot** - press this tab or the F12 key to take a screenshot and save it to USB flash drive (FAT/ FAT32 format only).
- **Temperature** - shows the temperatures of processor and the motherboard.

SETTINGS

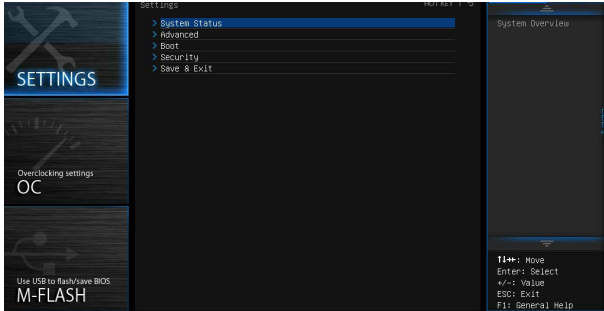

System Status

► System Date

Sets the system date. Use tab key to switch between date elements.

The format is <day> <month> <date> <year>.

- <day> Day of the week, from Sun to Sat, determined by BIOS. Read-only.
- <month> The month from Jan. through Dec.
- <date> The date from 1 to 31 can be keyed by numeric function keys.
- <year> The year can be adjusted by users.

► System Time

Sets the system time. Use tab key to switch between time elements.

The time format is <hour> <minute> <second>.

► SATA PortX

Shows the information of connected SATA device.



Important

If the connected SATA device is not displayed, turn off computer and re-check SATA cable and power cable connections of the device and motherboard.

► System Information

Shows detailed system information, including CPU type, BIOS version, and Memory (read only).

► DMI Information

Shows system information, desktop Board Information and chassis Information. (Read only).

Advanced

► PCI Subsystem Settings

Sets PCI, PCI express interface protocol and latency timer. Press **Enter** to enter the sub-menu.

▶ **PCI Latency Timer [32]**

Sets latency timer of PCI interface device.

[Options: 32, 64, 96, 128, 160, 192, 224, 248 PCI Bus clocks]

▶ **ACPI Settings**

Sets ACPI parameters of onboard power LED behaviors. Press **Enter** to enter the sub-menu.

▶ **ACPI Standby State**

Specifies the power saving modes for ACPI function.

▶ **Power LED [Blinking]**

Sets shining behaviors of the onboard Power LED.

[Dual Color] The power LED turns to another color to indicate the S3 state.

[Blinking] The power LED blinks to indicate the S3 state.

▶ **Integrated Peripherals**

Sets integrated peripherals' parameters, such as LAN, HDD, USB and audio. Press **Enter** to enter the sub-menu.

▶ **Onboard LAN Controller [Enabled]**

Enables or disables the onboard LAN controller.

▶ **LAN Option ROM [Disabled]**

Enables or disables the legacy network Boot Option ROM for detailed settings. This item will appear when **Onboard LAN Controller** is enabled.

[Enabled] Enables the onboard LAN Boot ROM.

[Disabled] Disables the onboard LAN Boot ROM.

▶ **Network Stack [Disabled]**

Sets UEFI network stack for optimizing IPv4 / IPv6 function.

[Enabled] Enables UEFI network stack.

[Disabled] Disables UEFI network stack.

▶ **Ipv4 PXE Support [Enabled]**

When **Enabled**, the system UEFI network stack will support Ipv4 protocol. This item will appear when **Network Stack** is enabled.

[Enabled] Enables the Ipv4 PXE boot support.

[Disabled] Disables the Ipv4 PXE boot support.

▶ **Ipv6 PXE Support [Enabled]**

When **Enabled**, the system UEFI network stack will support Ipv6 protocol. This item will appear when **Network Stack** is enabled.

[Enabled] Enables the Ipv6 PXE boot support.

[Disabled] Disables the Ipv6 PXE boot support.

▶ **SATA Mode [AHCI Mode]**

Sets the operation mode of the onboard SATA controller.

[AHCI Mode] Specify the AHCI mode for SATA storage devices. AHCI (Advanced Host Controller Interface) offers some advanced features to enhance the speed and performance of SATA storage device, such as Native Command Queuing (NCQ) and hot-plugging.

[RAID Mode] Enables RAID function for SATA storage devices.

▶ **SATAx Hot Plug [Disabled]**

Allows user to enable or disable the SATA hot plug support.

[Enabled] Enables hot plug support for the SATA ports.

[Disabled] Disables hot plug support for the SATA ports.

▶ **HD Audio Controller [Enabled]**

Enables or disables the onboard High Definition Audio controller.

▶ **HPET [Enabled]**

Enables or disables the HPET (High Precision Event Timers) support.

▶ **USB Configuration**

Sets the onboard USB controller and device function. Press <Enter> to enter the sub-menu.

▶ **USB Controller [Enabled]**

Enables or disables all USB controller.

▶ **XHCI Hand-off [Enabled]**

Enables or disables XHCI hand-off support for the operating system without XHCI hand-off feature. This item will appear when **USB Controller** is enabled.

▶ **EHCI Hand-off [Enabled]**

Enables or disables EHCI hand-off support for the operating system without EHCI hand-off feature.

▶ **Legacy USB Support [Enabled]**

Sets Legacy USB function support.

[Auto] The system will automatically detect if any USB device is connected and enable the legacy USB support.

[Enabled] Enable the USB support under legacy mode.

[Disabled] The USB devices will be unavailable under legacy mode.

▶ **Onboard USB 3.0 Controller [Enabled]**

Enables or disables the external USB 3.0 controller.

▶ **Super IO Configuration**

Sets system Super I/O chip parameters including LPT and COM ports. Press **Enter** to enter the sub-menu.

▶ **Serial (COM) Port 0 Configuration**

Sets detailed configuration of serial(COM) port x. Press <Enter> to enter the sub-menu.

▶ **Serial (COM) Port 0 [Enabled]**

Enables or disables serial (COM) port x.

▶ **Serial (COM) Port 0 Settings [Auto]**

Sets serial port x (COM). If set to Auto, BIOS will optimize the IRQ automatically or you can set it manually.

▶ **Power Management Setup**

Sets system Power Management of EuP2013 and AC Power Loss behaviors. Press **Enter** to enter the sub-menu.

▶ **EuP 2013 [Disabled]**

Enables or disables the system power consumption according to EuP2013 regulation. When **enabled**, the system will not support RTC wake up event functions.

[Enabled] Optimize the system power consumption according to EuP 2013 regulation. It will not support S4 & S5 wake up by USB and PCIe devices.

[Disabled] Disables this function.

▶ **Restore after AC Power Loss [Power Off]**

Sets the system behaviors while encountering the AC power loss.

[Power Off] Leaves the system in power off state after restoring AC power.

[Power On] Boot up the system after restoring AC power.

[Last State] Restores the system to the previous state (power on/ power off) before AC power loss.

▶ **Windows 8 Configuration**

Sets Windows 8/ 8.1 detailed configuration and behaviors. Press <Enter> to enter the sub-menu.

▶ **Windows 8 Feature [Disabled]**

Enables the supports for Windows 8/ 8.1 or disables for other operating systems. Before enabling this item, make sure all installed devices & utilities (hardware & software) should meet the Windows 8/ 8.1 requirements.

[Enabled] The system will switch to UEFI mode to meet the Windows 8 requirement.

[Disabled] Disables this function.

▶ **MSI Fast Boot [Disabled]**

MSI Fast Boot is the fastest way to boot the system. It will disable more devices to speed up system boot time which is faster than the boot time of **Fast Boot**.

[Enabled] Enables the MSI Fast Boot function to speed up booting time. And the following **Fast Boot** field will be disabled and fixed.

[Disabled] Disables MSI Fast Boot.

 **Important**

When MSI Fast Boot is enabled, you can use **MSI FAST BOOT** application to enter BIOS setup if needed. Please refer **Entering BIOS Setup** section for details.

▶ **Fast Boot [Disabled]**

Enables or disables the fast boot feature for Windows 8/ 8.1. This item will only be available when **MSI Fast Boot** is disabled.

[Enabled] Enables the Fast Boot configuration to accelerate system boot time.

[Disabled] Disables the Fast Boot configuration.

▶ **Wake Up Event Setup**

Sets system wake up behaviors for different sleep modes. Press <Enter> to enter the sub-menu.

▶ **Wake Up Event By [BIOS]**

Selects the wake up event by BIOS or operating system.

[BIOS] Activates the following items, set wake up events of these items.

[OS] The wake up events will be defined by OS.

▶ **Resume By RTC Alarm [Disabled]**

Enables or disables the system wake up by RTC Alarm.

[Enabled] Enables the system to boot up on a scheduled time/ date.

[Disabled] Disables this function.

▶ **Date (of month) Alarm/ Time (hh:mm:ss) Alarm**

Sets RTC alarm date/ Time. If Resume By RTC Alarm is set to [Enabled], the system will automatically resume (boot up) on a specified date/hour/minute/second in these fields (using the <+> and <-> to select the date & time settings).

▶ **Resume By PCI-E Device [Disabled]**

Enables or disables the system wake up by PCI-E devices.

[Enabled] Enables the system to be awakened from the power saving modes when activity or input signal of PCI-E device is detected. Note: enables this Item to support **Resume by USB Device** with third party USB port if any.

[Disabled] Disables this function.

▶ **Resume From S3 by USB Device [Disabled]**

Enables or disables the system wake up by USB devices.

[Enabled] Enables the system to be awakened from S3 (suspend to RAM) sleep state when activity of USB device is detected.

[Disabled] Disables this function.

▶ **Resume From S3/S4/S5 by PS/2 Mouse [Disabled]**

Enables or disables the system wake up by PS/2 mouse.

[Enabled] Enables the system to be awakened from S3/ S4/ S5 state when activity of PS/2 mouse is detected.

[Disabled] Disables this function.

▶ Resume From S3/S4/S5 by PS/2 Keyboard [Disabled]

Enables or disables the system wake up by PS/2 keyboard.

[Any Key] Enables the system to be awakened from S3/ S4/ S5 state when activity of any key on PS/2 keyboard is detected.

[Hot Key] Enables the system to be awakened from S3/ S4/ S5 state when activity of hot key on PS/2 keyboard is detected.

[Disabled] Disables this function.

Boot

Sets the sequence of system boot devices.

▶ Full Screen Logo Display [Enabled]

Enables or disables to show the full screen logo while system POST.

[Enabled] Shows the logo in full screen.

[Disabled] Shows the POST messages.

▶ Boot Mode Select [LEGACY+UEFI]

Sets the system boot mode from legacy or UEFI architecture depending on OS installation requirement. This item will become un-selectable and will be configured automatically by BIOS when **Windows 8 Feature** is enabled.

[UEFI] Enables UEFI BIOS boot mode support only.

[LEGACY+UEFI] Enables both Legacy BIOS boot mode and UEFI BIOS boot mode.

▶ FIXED BOOT ORDER Priorities

Sets device priority for system boot.

▶ Boot Option Priorities

These items are used to prioritize the installed boot devices.

Security

▶ Administrator Password

Sets administrator password for system security. User has full rights to change the BIOS items with administrator password. After setting the administrator password, the state of this item will show "Installed".

▶ User Password

Sets User Password for system security. User has limited rights to change the BIOS items with user password. This item will be available when administrator password is set. After setting the user password, the state of this item will show **Installed**.

Important

When selecting the Administrator / User Password items, a password box will appear on the screen. Type the password then press <Enter>. The password typed now will replace any previous set password from CMOS memory. You will be prompted to confirm the password. You may also press <Esc> to abort the selection.

To clear a set password, press <Enter> when you are prompted to enter a new password. A message will confirm the password is being disabled. Once the password is disabled, you can enter the setup and OS without authorization.

▶ **U-Key [Disabled]**

Enables or disables U-Key as user's password to access the system.

▶ **Make U-Key at**

Makes a key at the USB flash drive to prevent other people from accessing the system. Only the user who has the key with the flash drive can access the system.

▶ **Chassis Intrusion Configuration**

Press **Enter** to enter the sub-menu.

▶ **Chassis Intrusion [Disabled]**

Enables or disables recording messages when the chassis is opened. This function is ready for the chassis equips a chassis intrusion switch.

[Enabled] Once the chassis is opened, the system will record and issue a warning message.

[Reset] Clear the warning message. After clearing the message, please return to **Enabled** or **Disabled**.

[Disabled] Disables this function.

Save & Exit

▶ **Discard Changes and Exit**

Exit BIOS setup without saving any change.

▶ **Save Changes and Reboot**

Save all changes and reboot the system.

▶ **Save Changes**

Save current changes.

▶ **Discard Changes**

Discard all changes and restore to the previous values.

▶ **Restore Defaults**

Restore or load all default values.

▶ **Boot Override**

The installed bootable devices will appear on this menu, you can select one of them to be the boot device.

OC

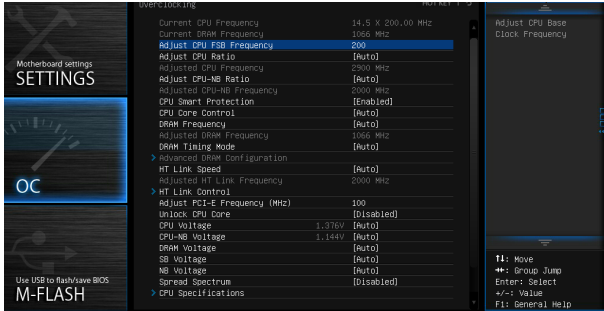

Important

- Overclocking your PC manually is only recommended for advanced users.
- Overclocking is not guaranteed, and if done improperly, it could void your warranty or severely damage your hardware.
- If you are unfamiliar with overclocking, we advise you to use OC Genie function for easy overclocking.

▶ Current CPU/ DRAM Frequency

These items show the current frequencies of installed CPU and Memory. Read-only.

▶ Adjust CPU FSB Frequency

Allows you to set the CPU FSB frequency (in MHz). You may overclock the CPU by adjusting this value. Please note that overclocking behavior and stability is not guaranteed.

▶ Adjust CPU Ratio [Auto]

Sets the CPU ratio that is used to determine CPU clock speed. This item can only be changed if the processor supports this function.

▶ Adjusted CPU Frequency

Shows the adjusted CPU frequency. Read-only.

▶ Adjust CPU-NB Ratio [Auto]

Sets the CPU-NB ratio that is used to determine CPU-NB clock speed.

▶ Adjusted CPU-NB Frequency

Shows the adjusted CPU frequency. Read-only.

▶ CPU Smart Protection [Enabled]

CPU Smart Protection is a mechanism of CPU overheating protection. It will automatically reduce the clock when the CPU temperature gets too high.

▶ CPU Core Control [Auto]

This item allows you to select the number of active processor cores. When set to **Auto**, the CPU will operate under the default number of cores.

▶ DRAM Frequency [Auto]

Sets the DRAM frequency. Please note the overclocking behavior is not guaranteed.

▶ Adjusted DRAM Frequency

Shows the adjusted DRAM frequency. Read-only.

▶ DRAM Timing Mode [Auto]

Selects the memory timing mode.

[Auto] DRAM timings will be determined based on SPD (Serial Presence Detect) of installed memory modules.

[Link] Allows user to configure the DRAM timing manually for all memorychannel.

[UnLink] Allows user to configure the DRAM timing manually for respective memory channel.

▶ Advanced DRAM Configuration

Press **Enter** to enter the sub-menu. This sub-menu will be activated after setting **Link** or **Unlink** in **DRAM Timing Mode**. User can set the memory timing for each memory channel. The system may become unstable or unbootable after changing memory timing. If it occurs, please clear the CMOS data and restore the default settings. (Refer to the **Clear CMOS jumper** section to clear the CMOS data, and enter the BIOS to load the default settings.)

▶ HT Link Speed [Auto]

This item allows you to set the Hyper-Transport Link speed. When **Auto**, the system will detect the HT link speed automatically.

▶ Adjusted HT Link Frequency

It shows the adjusted HT Link frequency. Read-only.

▶ HT Link Control

Press **Enter** to enter the sub-menu.

▶ HT Incoming/ Outgoing Link Width

These items allow you to set the Hyper-Transport Link width. When **Auto**, the system will detect the HT link width automatically.

▶ Adjust PCI-E Frequency (MHz)

Sets the PCI Express frequency.

▶ Unlock CPU Core [Disabled]

This item is used to unlock the CPU core. Please refer to the procedures below for CPU core unlocked in BIOS setup.

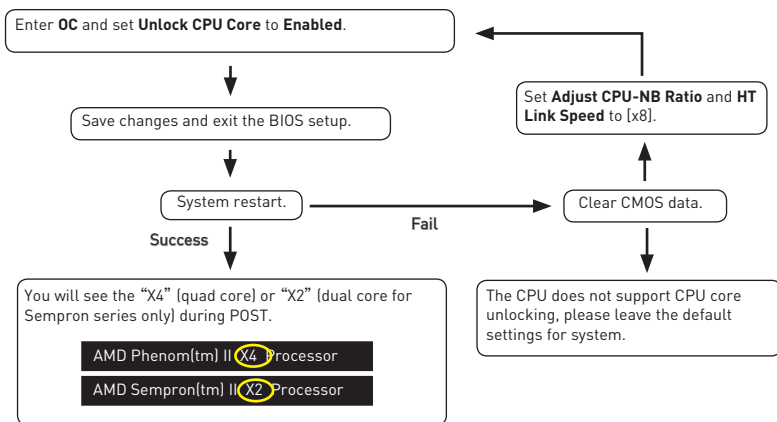

Important

- This CPU core unlocked behavior depends on the CPU ability/ characteristic, and it is not guaranteed.
- Depend on CPU's characteristic, once you get instable scenario, please restore the default settings for system.
- You can also check the core numbers in performance tab of Windows task manager.

▶ CPU/ CPU-NB/ DRAM/ SB/ NB Voltages control [Auto]

These options allows you to set the voltages related to CPU/ memory/ SB/ NB. If set to **Auto**, BIOS will set these voltages automatically or you can set it manually.

▶ Spread Spectrum [Disabled]

This function reduces the EMI (Electromagnetic Interference) generated by modulating clock generator pulses.

[Enabled] Enables the spread spectrum function to reduce the EMI (Electromagnetic Interference) problem.

[Disabled] Enhances the overclocking ability of CPU Base clock.

Important

- If you do not have any EMI problem, leave the setting at [Disabled] for optimal system stability and performance. But if you are plagued by EMI, select the value of Spread Spectrum for EMI reduction.
- The greater the Spread Spectrum value is, the greater the EMI is reduced, and the system will become less stable. For the most suitable Spread Spectrum value, please consult your local EMI regulation.
- Remember to disable Spread Spectrum if you are overclocking because even a slight jitter can introduce a temporary boost in clock speed which may just cause your overclocked processor to lock up.

▶ CPU Specifications

Press **Enter** to enter the sub-menu. This sub-menu displays the information of installed CPU. You can also access this information menu at any time by pressing **F4**. Read only.

▶ CPU Technology Support

Press **Enter** to enter the sub-menu. The sub-menu shows the key features of installed CPU. Read only.

▶ MEMORY-Z

Press **Enter** to enter the sub-menu. This sub-menu displays all the settings and timings of installed memory. You can also access this information menu at any time by pressing **F5**.

▶ DIMMx Memory SPD

Press <Enter> to enter the sub-menu. The sub-menu displays the information of installed memory. Read only.

▶ CPU Features

Press **Enter** to enter the sub-menu.

▶ AMD Cool' n' Quiet [Auto]

Enabled or disabled AMD Cool' n' Quiet function.

[Auto] Depends on AMD Design.

[Enable] Enables AMD Cool' n' Quiet function. The Cool' n' Quiet technology can effectively and dynamically lower CPU speed and power consumption.

[Disabled] Disables this function.

Important

*When adjusting CPU Ratio, the **Cool' n' Quiet** function will be disabled automatically. For CPU which supports the **Turbo Core Tech.**, please set **AMD Turbo Core Technology** and **AMD Cool' n' Quiet** as **Disabled** to retain the default CPU core speed.*

▶ C1E Support

Enables this item to reduce the CPU power consumption while idle. Not all processors support Enhanced Halt state (C1E).

▶ SVM Mode [Enabled]

Enables or disables CPU Virtualization.

[Enabled] Enables CPU Virtualization and allows a platform to run multiple operating systems in independent partitions. The system can function as multiple systems virtually.

[Disabled] Disables this function.

▶ IOMMU Mode

Enables/disables the IOMMU (I/O Memory Management Unit) for I/O Virtualization.

M-FLASH

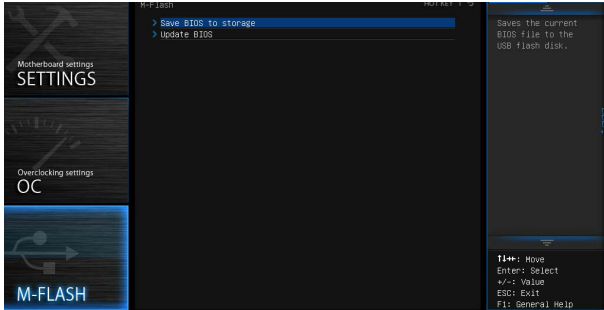

Important

M-Flash function allows you to update BIOS from USB flash disk (FAT32/ NTFS format only).

▶ **Save BIOS to storage**

Saves the current BIOS file to the USB flash disk. The USB flash disk drive should be in FAT32 format.

▶ **Update BIOS**

Selects a BIOS file in the USB flash disk (NTFS/ FAT32 format) to update the BIOS.

▶ **Select one file to update BIOS**

Selects a BIOS file in the USB flash disk (NTFS/ FAT32 format)

OC PROFILE

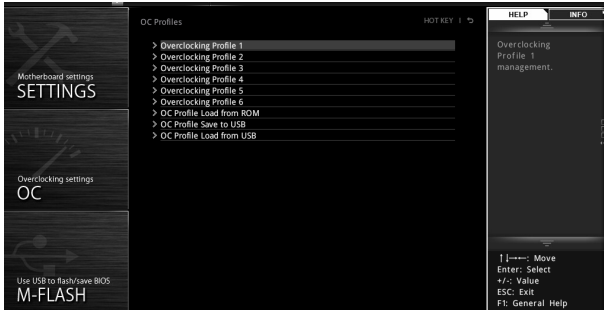

► Overclocking Profile 1/ 2/ 3/ 4/ 5/ 6

Overclocking Profile 1/ 2/ 3/ 4/ 5/ 6 management. Press **Enter** to enter the sub-menu.

► Set Name for Overclocking Profile 1/ 2/ 3/ 4/ 5/ 6

Name the current overclocking profile.

► Save Overclocking Profile 1/ 2/ 3/ 4/ 5/ 6

Save the current overclocking profile.

► Load Overclocking Profile 1/ 2/ 3/ 4/ 5/ 6

Load the current overclocking profile.

► Clear Overclocking Profile 1/ 2/ 3/ 4/ 5/ 6

Clear the current overclocking profile.

► OC Profile Save to USB

Save OC profile to the USB flash drive. The USB flash drive should be FAT/ FAT32 format only.

► OC Profile Load from USB

Load OC profile from the USB flash drive. The USB flash drive should be FAT/ FAT32 format only.

HARDWARE MONITOR

Temperature & Speed graphic display

Hardware Monitor

Monitor Changing Channel to show comparison in the monitor.

Temperature CPU 33 (°C)
System 30 (°C)

Fan Speed CPU 1 1570 (RPM)
System 1 1625 (RPM)
System 3 2617 (RPM)

Fan Control CPU 1 System 1 System 3

Target Temperature (°C) Min
Min Fan Speed (RPM) 19.5 25 37.5 50 62.5 75 87.5
Max Fan Speed (RPM) 34 37.5 50 62.5 75 87.5 100%

Voltage (v)

1.368 11.704 4.680
CPU/Vcore System/12V System/5V

Temperature & Speed information

Fan control field

Voltage display

► Temperature & Speed information

Shows the current CPU temperature, system temperature and fans' speeds.

► Temperature & Speed graphic display

The red graph shows the minimum and maximum temperatures that be set on the **Fan control field**. The yellow graph shows current CPU/ system temperature. The green shows current CPU/ System fan speed.

► Fan control field

Smart Fan Control automatically controls fan speed depending on the current CPU temperature and to keep it with a specific operating speed. When the current CPU temperature is over the maximum temperature, the CPU/ system fan will run at the maximum speed. When the current CPU temperature is under the minimum temperature, the CPU/ system fan will run at the minimum speed. In this field, you can set the CPU and system fans' speeds and target temperatures.

Important

The changing will achieve after you save the changes and reboot the system.

► Voltage display

Shows the current voltages of CPU, system and memory.

Software Description

Installing Drivers

1. Start up your computer in Windows® 7/ 8.1/ 10.
2. Insert MSI® Driver Disc into your optical drive.
3. The installer will automatically appear and it will find and list all necessary drivers.
4. Click **Install** button.
5. The software installation will then be in progress, after it has finished it will prompt you to restart.
6. Click **OK** button to finish.
7. Restart your computer.

Installing Utilities

Before you install utilities, you must complete drivers installation.

1. Insert MSI® Driver Disc into your optical drive.
2. The installer will automatically appear.
3. Click **Utilities** tab.
4. Select the utilities you want to install.
5. Click **Install** button.
6. The utilities installation will then be in progress, after it has finished it will prompt you to restart.
7. Click **OK** button to finish.
8. Restart your computer.

COMMAND CENTER

COMMAND CENTER is a user-friendly software and exclusively developed by MSI, helping users to adjust system settings and monitor status under OS. With the help of **COMMAND CENTER**, making it possible to achieve easier and efficient monitoring process and adjustments than that under BIOS. In addition, the **COMMAND CENTER** can be a server for mobile remote control application.



Profile Buttons



- **Default** - load the default values for the current feature.
- **Apply** - apply your changes.
- **Save** - store values in the file with individual file extension.
- **Load** - load the values from the file.

Important

Every time you shut down the system, the configured setting will be restored to the factory default. If you want to use the saved settings, you have to load it every time by clicking the **Load** and **Apply** buttons.

CPU Frequency

CPU Frequency control panel allows you to change CPU Ratio and Base clock. You can see the current frequency of each CPU core on the top of the panel.

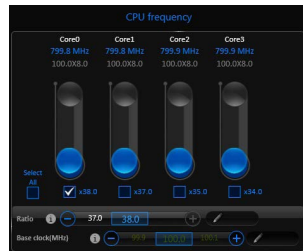

CPU Fan

CPU Fan control panel provides **Smart mode** and **Manual Mode**. You can switch the control mode by clicking the **Smart Mode** and **Manual Mode** buttons on the top of the CPU Fan control panel.

- **Manual Mode** - allows you to manually control the CPU fan speed by percentage.
- **Smart Mode** - a linear fan speed control feature. The control panel contains 4 dots allows you to drag and adjust the Smart Speed slopes. The fan speed will be changed along these lines with CPU temperature. The white dot will create strip chart in real time.
- **System Fan Button** - to open the system fan control panel in new window.
- **Fan Tune Button** - to automatically optimize the smart fan setting.

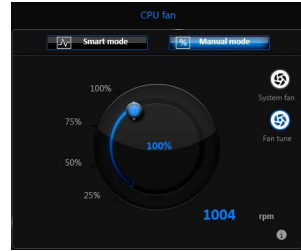

Manual Mode

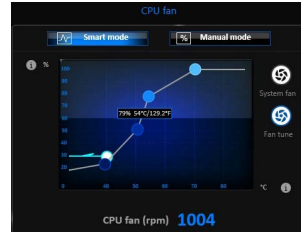

Smart Mode

CPU Voltage

CPU Voltage control panel allows you to control the CPU voltage.

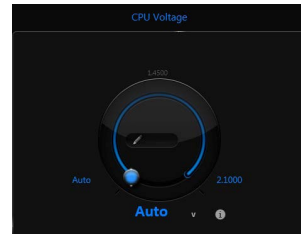

DRAM Frequency & DRAM Voltage

- **DRAM Frequency** - Shows the DRAM clock, ratio and frequency.
- **DRAM Voltage** - Allows you to adjust the DRAM voltage. The risky values are displayed in red.



IGP Frequency & GT Voltage

- **IGP Frequency** - Allows you to adjust the IGP ratio, and shows the IGP clock, ratio and frequency.
- **GT Voltage** - Allows you to adjust the GT voltage. The risky values are displayed in red.



Option Buttons - Advanced

When click the **Advanced** button, The **Voltage**, **Fan** and **DRAM** icons will appear.



- **Voltage** - allows you to adjust advanced voltage values of CPU and chipset.
- **Fan** - allows you to control the system fans speed.
- **DRAM** - shows the current Advanced DRAM parameters, and allows you to change the settings by selecting values from the drop-down menu on the right hand side.

Option Buttons - Setting

When click the **Setting** button, The **Record**, **Warning** and **Mobile Control** icons will appear.



- **Record** - allows you to monitor the status of voltage, fan speed and temperature in real time.
 - To filter record charts, select the check box next to the items.
 - When click the **Play** button, the chart pane will start to show the recording chart. If you want to check the value of a specific spot on chart, please move the orange vertical line to the spot.
 - History Record stores the data and names with date and time.
 - To make a history record: Select items and click the **Record** button. When finished, click the **Record** button again. The data will be stored in the drop-down menu.
 - To load a record, click the drop-down menu and select one from the list.
 - To delete a record, select the record that you want to delete, and click the **Trash Can** icon.

- **Warning** - contains fields of voltage, fan speed and temperature for you to set the threshold values. When system detects the status over your settings, a warning message will pop-up.

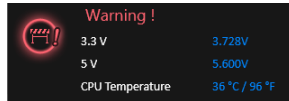

- **Mobile Control** - is only available for the motherboard with the built-in WiFi module. It allows you to enable/disable the COMMAND CENTER Remote Server. Please refer to the instruction on the Mobile Control control panel.
- **To start remote control: (optional)**
 1. Download and install **MSI® COMMAND CENTER APP** to your mobile device.
 2. Enable **COMMAND CENTER Remote Server** on the **Mobile Control** panel.
 3. Enable **SoftAP Management**.
 4. Enter **SSID** and **Password**, and then click the **Apply** button.
 5. Activate Wi-Fi® on your mobile device and connect to SoftAP with the SSID.
 6. Run **MSI® COMMAND CENTER APP** on your mobile device.
 7. Find the IP address on the **SoftAP Management Setting** area, and enter the IP address on your **MSI® COMMAND CENTER APP** to link your system.
 8. Press **Refresh** on the **MSI® COMMAND CENTER APP** to verify that monitoring and OC functions are working properly.

Option Buttons - Information

When click the **Information** button, The **Motherboard, CPU, Memory** and **HW monitor** icons will appear.



You can click the icons to open the related information.

Gadget Mode

COMMAND CENTER provides a gadget mode to monitor the system status. You can switch between gadget mode and full mode by clicking the arrow icon  on the top left.

- **To arrange gadgets:**

1. Click the Spanner icon  on the Gadget mode, a configuration panel will slide out.
2. Select the check box next to the items.
3. Click the **Close** button.

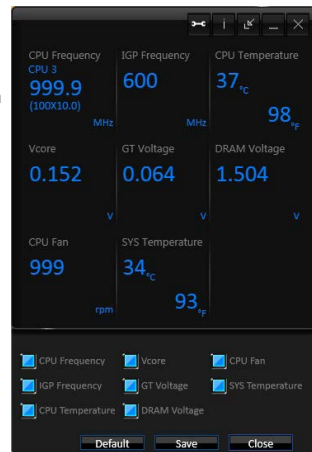

LIVE UPDATE 6

LIVE UPDATE 6 is an application for the MSI® system to scan and download the latest drivers, BIOS and utilities. With LIVE UPDATE 6, you don't need to search the drivers on websites, and don't need to know the models of motherboard and graphics cards. LIVE UPDATE 6 will download the appropriate drivers automatically.

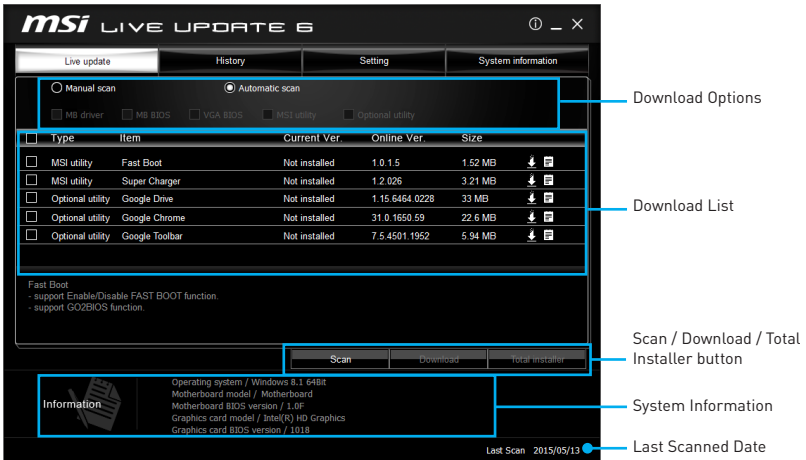

There are **Live Update**, **History**, **Setting** and **System Information** tabs at the top. You can click the tab to switch the control panel.

- **Live Update** - When you launch LIVE UPDATE 6, you will see the Live update tab at first. This tab allows you to select files to download. You can also read the relevant information by clicking the information icon  on the right of the item listed.
- **History** - shows the downloading history.
- **Setting** - allows you to specify the frequency that LIVE UPDATE 6 remind you to update.
- **System Information** - displays the information of the system.

Updating The System

This section describes how to update your system with LIVE UPDATE 6. Please follow the steps below:

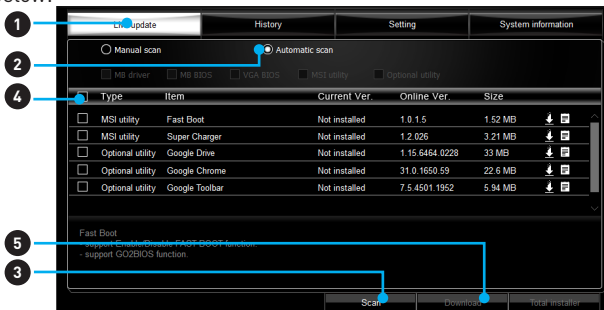

1. Select the **Live Update** tab.

- Choose **Automatic scan**, system will automatically scan all the items and search for the latest update files. Or you can choose **Manual scan** and select the items you wish to scan.
- Click the **Scan** button at the bottom. It may take several moments to complete the process.
- When the download list appears, please select the items you intend to update.
- Click **Download** button at the bottom.
- When **Save Path** prompt, you can specify a download directory.

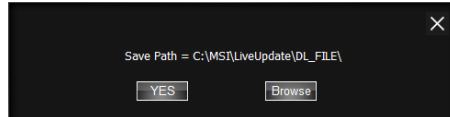

- When downloading you will see the screen below. It may take several moments to complete the process.

| Type | Item | Latest Ver. | Size | Download |
|-------------|---------------|-------------|---------|--------------------------------------|
| MSI utility | Fast Boot | 1.0.1.5 | 1.52 MB | <div style="width: 46%;"></div> 46 % |
| MSI utility | Super Charger | 1.2.026 | 3.21 MB | |

- To install the applications, simply unpack the packages and install.

Total Installer

Total Installer is a convenient feature to simplify frequent installing procedure. To use Total Installer:

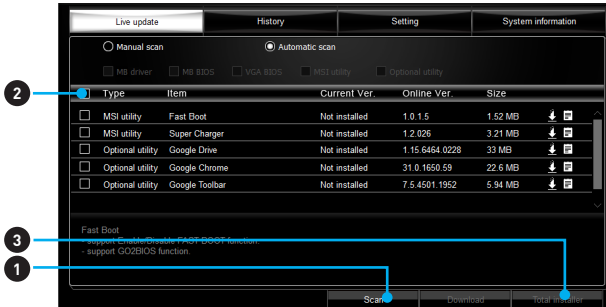

- Scan** updates in **Live Update** tab.
- Check the **Select All** check-box you intend to update.
- Click the **Total Installer** button. LIVE UPDATE 6 will automatically install them.
- When prompted, click **OK** to complete the Total Installer procedure.
- Reboot your system.

NETWORK GENIE

NETWORK GENIE is an utility to optimize the traffic for bandwidth control. **NETWORK GENIE** is designed for the Realtek LAN chip with Windows 7, Windows 8.1 and Windows 10 platforms.

Once installed, the Network Genie icon shows on system tray (the right bottom corner of the screen). Mouse right click at the icon, will display the following screen.

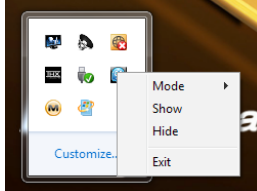

When you hover the mouse cursor over the **Mode** option, a sub-menu will appear for you to select **Game**, **Stream**, **Browser** and **Auto** mode.

- **Show** - shows the **NETWORK GENIE** control panel.
- **Hide** - hides the **NETWORK GENIE** control panel.
- **Exit** - exits **NETWORK GENIE**.

In case no icon is shown on the system tray, it is possible to activate **NETWORK GENIE** manually by clicking **Start > Programs > MSI > NETWORK GENIE > NETWORK GENIE**.

NETWORK GENIE Control Panel



- **Mode** - allows you to quickly change bandwidth priorities for different applications.
- **Applications** - lists all network related applications.
- **Advanced** - provides detailed settings for **NETWORK GENIE**.
- **System Info** - shows system information.
- **About** - shows information of **NETWORK GENIE**.

Configuring Application's Network Priority

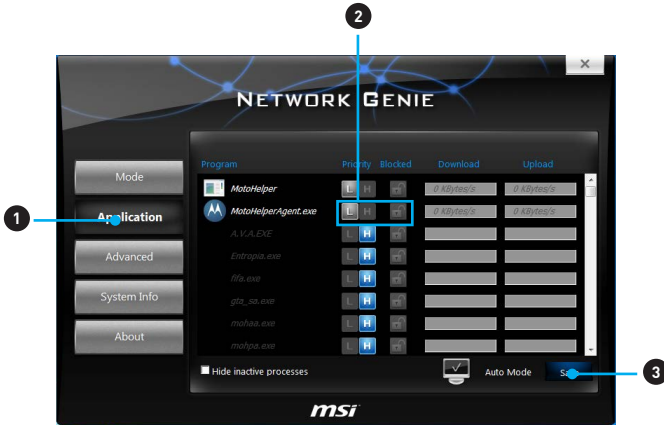

1. Go to **Application** tab.
2. Click **L** to assign the low network priority to the application, and **H** to high. You can also click the **Lock** icon to block an application network connection.
3. Click the **Save** button to store your settings.

Configuring Network Speed

There are two parts in the **Advanced** tab, one is **Internet Speed**, and another is **Delay/Sensitivity Settings**.

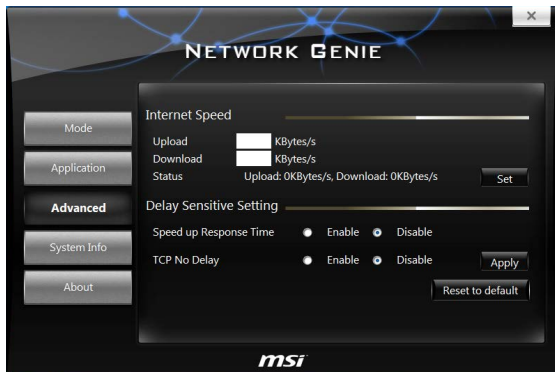

- **Internet Speed** - allows you to set the maximum available bandwidth to the upload/download speed manually or just leave blank for no limit.
- **Delay/Sensitivity Settings** - allows you to enable **Speed up Response Time** and **No TCP Delay** to reduce the latency of the high priority applications.

RAID Configuration

Below are the different types of a RAID.

- RAID 0** breaks the data into blocks which are written to separate hard drives. Spreading the hard drive I/O load across independent channels greatly improves I/O performance.
- RAID 1** provides data redundancy by mirroring data between the hard drives and provides enhanced read performance.
- RAID 5** provides data striping at the byte level and also stripe error correction information. This results in excellent performance and good fault tolerance.
- RAID 10** uses four hard drives to create a combination of RAID 0 and 1 by forming a RAID 0 array from two RAID 1 arrays.

RAID level comparison

| | RAID 0 | RAID 1 | RAID 5 | RAID 10 |
|----------------------|-----------|-----------|-------------|-----------|
| Minimum # drives | 2 | 2 | 3 | 4 |
| Data protection | None | Excellent | Excellent | Excellent |
| Read performance | Excellent | OK | Good | OK |
| Write performance | Excellent | Good | OK | Good |
| Capacity utilization | 100% | 50% | 67%~(1-1/n) | 50% |

Using AMD® RAID Option ROM utility

First, you need to set the **SATA mode** to **RAID** in BIOS to create, delete and reset RAID volumes. To enter the RAID Option ROM, reboot and press **Ctrl + F** keys to enter the RAID Option ROM utility during the POST, the following window will appear.

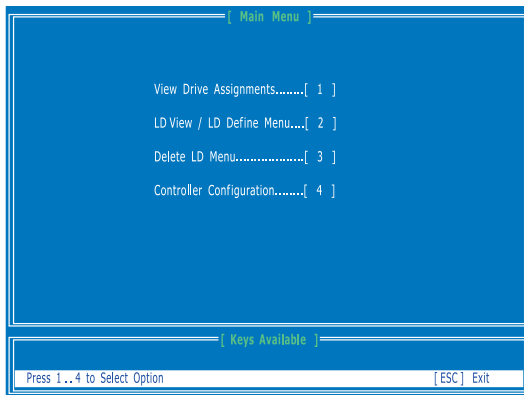

Important

The following procedure is only available with a newly-built system or if you are reinstalling your OS. It should not be used to migrate an existing system to RAID.

Creating RAID Volume

1. Press **2** on the main menu and then press **Ctrl + C** keys. Then following screen appears.

The screenshot shows a blue-themed RAID configuration interface. It is divided into three main sections:

- [LD Define Menu]**: A table with columns for LD No, LD Name, RAID Mode, and Drv. The first row shows LD 1, Logical Drive 1, RAID 1, and 0. Below this are settings for Stripe Block (Gigabyte), Boundary (ON), Fsat Init (ON), Cache Mode, and WriteThru.
- [Drives Assignments]**: A table with columns for Port : ID, Drive Model, Capabilities, Capacity (GB), and Assignment. It lists two drives: 01 : 00 and 02 : 00, both with model ST32000641AS, SATA 6G capabilities, and 2000.39 GB capacity, both assigned to 'N'.
- [Keys Available]**: A list of navigation keys: [↑] Up, [↓] Down, [PaUp / PaDn] Switch Page, [Space] Change Option, [Ctrl + Y] Save, and [ESC] Exit.

2. Use the space key to choose a RAID mode (RAID 0/ 1/ 10/ 5) and use the arrow key to move to the **Drives Assignments** window.
 - Stripe Block Size, the default 64KB is best for RAID 0 or 10.
 - Gigabyte Boundary, allows use of slightly smaller replacement drives.
3. On the **Drives Assignments** window, use the **arrow** keys to choose the hard drives which you want to make part of **RAID** volume, and use the **space** key to change the **Assignment** to **Y**. Then press **Ctrl + Y** keys to save the configuration.
4. A message will show, press **Ctrl + Y** to manually input a name as a **RAID** volume name or press any key to save default name.

Please press Ctrl-Y key to input the LD Name or press any key to exit.
If you do not input any LD name, the default LD name will be used.

5. Another message will show, press **Ctrl + Y** keys if you are sure to erase the MBR data of the disk. Or press any key to ignore this option.

Fast Initialization Option has been selected.
It will erase the MBR data of the disks.
<Press Ctrl-Y key if you are sure to erase it>
<Press any other key to ignore this option>

6. The message will show up on the bottom, press any key to use maximum capacity or press **Ctrl + Y** keys to modify array capacity manually.

Press Ctrl-Y to Modify Array Capacity or press any other key to use maximum capacity...

 **Important**

Since you want to create two volumes, this default size (maximum) needs to be reduced. Type in a new size for the first volume. As an example: if you want the first volume to span the first half of the two disks, re-type the size to be half of what is shown by default. The second volume, when created, will automatically span the remainder of two hard drives.

7. The **RAID** creation is done, the screen shows the information as below. Press **ESC** key to return to the main screen.

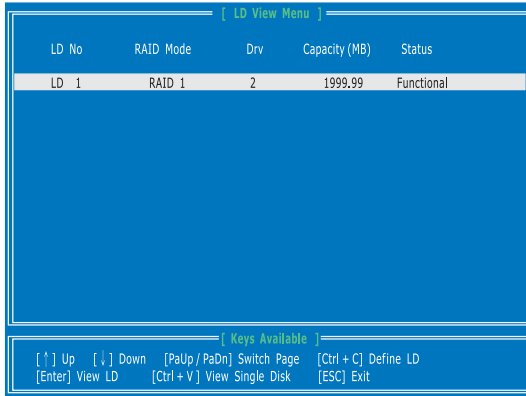

| LD No | RAID Mode | Drv | Capacity (MB) | Status |
|-------|-----------|-----|---------------|------------|
| LD 1 | RAID 1 | 2 | 1999.99 | Functional |

Keys Available

| | | | |
|-----------------|-----------------------------|---------------------------|----------------------|
| [↑] Up | [↓] Down | [PaUp / PaDn] Switch Page | [Ctrl + C] Define LD |
| [Enter] View LD | [Ctrl + V] View Single Disk | [ESC] Exit | |

8. Finally, press **ESC** key to exit the utility, a message **System is going to REBOOT! Are You Sure?** will display, press **Y** to exit it and the system will reboot.

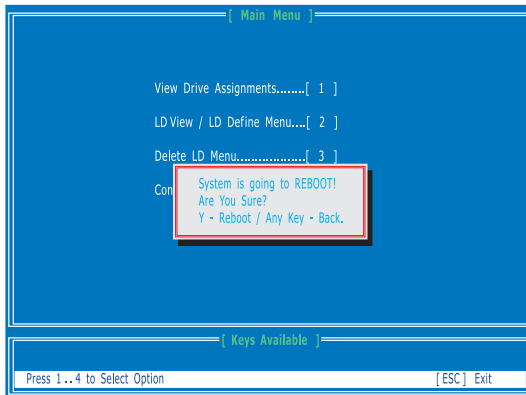

Main Menu

- View Drive Assignments.....[1]
- LD View / LD Define Menu....[2]
- Delete LD Menu.....[3]
- Con [System is going to REBOOT!
Are You Sure?
Y - Reboot / Any Key - Back.

Keys Available

| | |
|-----------------------------|------------|
| Press 1..4 to Select Option | [ESC] Exit |
|-----------------------------|------------|

Delete RAID Volume

Here you can delete the RAID volume, but please be noted that all data on RAID drives will be lost.



If your system currently boots to RAID and you delete the RAID volume in the RAID Option ROM, your system will become unbootable.

1. Press **3** on the main menu to enter the **Delete LD Menu**.
2. Choose a **LD No** you want to delete and press **Del** key or **Alt + D** keys to delete the **RAID** volume.

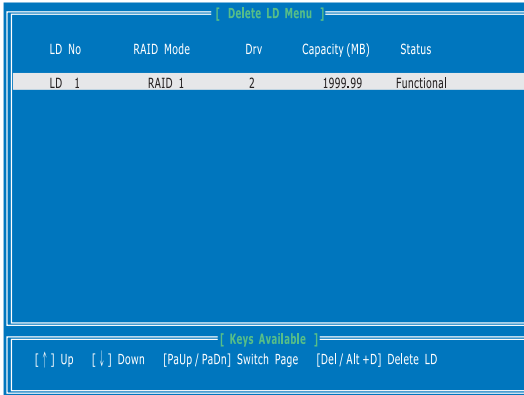

3. A message will display, press **Ctrl + Y** to delete the RAID volume.

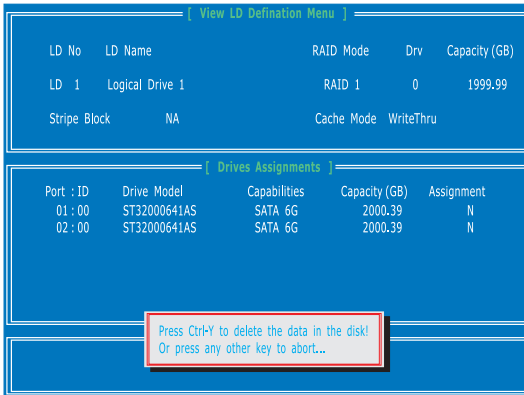

Troubleshooting

Before sending the motherboard for RMA repair, try to go over troubleshooting guide first to see if your got similar symptoms as mentioned below.

The power is not on.

- Connect the AC power cord to an electrical outlet securely.
- Check if all ATX power connectors like **JPWR1~2** is connected from the power supply to the motherboard?
- Some power supply units have a power button on the rear side, make sure the button is turned on.
- Check if the power switch cable is connected to **JFP1** pin header properly.
- Verify the **Clear CMOS** jumper **JBAT1** is set to **Keep DATA**.
- Test with another known working power supply of equal or greater wattage.

The power is on, but no signal to monitor

- Connect the monitor power cord to a electrical outlet securely.
- Make sure the monitor is turned on.
- Select different inputs on the monitor.
- If 3 long beeps are heard, remove all memory modules and try to install only one memory module into the **DIMM1** slot first and then restart the computer.
- If 1 long 2 short beeps are heard, remove and reinstall the graphics card and then restart the computer.
- Test with another known working graphics card.

The computer does not boot after updating the BIOS

- Clear the CMOS.
- Use the secondary BIOS to bootup the system (Only for motherboard with Dual BIOS)

Lost BIOS password

- Clear the CMOS, but that will cause you to lose all customized settings in the BIOS.

There is no audio

- Adjust the volume.
- Connect the speakers/headphones to audio ports on the motherboard rear IO panel.
- Test with another known working speaker or headphone.

There is no network

- Make sure the network chipset driver has been installed.
- Verify if the network cable is properly connected and make sure the LAN port LEDs are properly illuminated.
- Verify your TCP/IP settings.
- Restart or reset your router.
- Test with another known working LAN cable.

The USB device is not working

- Make sure your USB driver has been installed.
- Verify if USB device is listed in Windows® Device Manager.
- Connect the USB device to other USB port on the motherboard rear IO panel.

Regulatory Notices

FCC Compliance Statement

Note: This equipment has been tested and found to comply with the limits for a Class B digital device, pursuant to part 15 of the FCC Rules. These limits are designed to provide reasonable protection against harmful interference in a residential installation. This equipment generates, uses and can radiate radio frequency energy and, if not installed and used in accordance with the instructions, may cause harmful interference to radio communications. However, there is no guarantee that interference will not occur in a particular installation. If this equipment does cause harmful interference to radio or television reception, which can be determined by turning the equipment off and on, the user is encouraged to try to correct the interference by one or more of the following measures:

- Reorient or relocate the receiving antenna.
- Increase the separation between the equipment and receiver.
- Connect the equipment into an outlet on a circuit different from that to which the receiver is connected.
- Consult the dealer or an experienced radio/TV technician for help.

Caution: Changes or modifications not expressly approved by the party responsible for compliance could void the user's authority to operate the equipment.

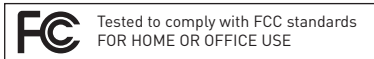

This device complies with part 15 of the FCC Rules. Operation is subject to the following two conditions:
(1) This device may not cause harmful interference, and
(2) this device must accept any interference received, including interference that may cause undesired operation.

CE Conformity

 Hereby, Micro-Star International CO., LTD declares that this device is in compliance with the essential safety requirements and other relevant provisions set out in the European Directive.

C-Tick Compliance



B급 기기 (가정용 방송통신기자재)

 이 기기는 가정용(B급) 전자파적합기기로서 주 로 가정에서 사용하는 것을 목적으로 하며, 모든 지역에서 사용할 수 있습니다.

クラスB情報技術装置

 この装置は、クラスB情報技術装置です。この装置は、家庭環境で使用することを目的としていますが、この装置がラジオやテレビジョン受信機に近接して使用されると、受信障害を引き起こすことがあります。取扱説明書に従って正しい取り扱いをして下さい

VCCI-B

Battery Information

European Union:



Batteries, battery packs, and accumulators should not be disposed of as unsorted household waste. Please use the public collection system to return, recycle, or treat them in compliance with the local regulations.

Taiwan:



廢電池請回收

For better environmental protection, waste batteries should be collected separately for recycling or special disposal.

California, USA:



The button cell battery may contain perchlorate material and requires special handling when recycled or disposed of in California.

For further information please visit:

<http://www.dtsc.ca.gov/hazardouswaste/perchlorate/>

CAUTION: There is a risk of explosion, if battery is incorrectly replaced.
Replace only with the same or equivalent type recommended by the manufacturer.

Chemical Substances Information

In compliance with chemical substances regulations, such as the EU REACH Regulation (Regulation EC No. 1907/2006 of the European Parliament and the Council), MSI provides the information of chemical substances in products at:
http://www.msi.com/html/popup/csr/evmtprtt_pcm.html

WEEE (Waste Electrical and Electronic Equipment) Statement

ENGLISH

To protect the global environment and as an environmentalist, MSI must remind you that...

Under the European Union ("EU") Directive on Waste Electrical and Electronic Equipment, Directive 2002/96/EC, which takes effect on August 13, 2005, products of "electrical and electronic equipment" cannot be discarded as municipal wastes anymore, and manufacturers of covered electronic equipment will be obligated to take back such products at the end of their useful life. MSI will comply with the product take back requirements at the end of life of MSI-branded products that are sold into the EU. You can return these products to local collection points.



DEUTSCH

Hinweis von MSI zur Erhaltung und Schutz unserer Umwelt

Gemäß der Richtlinie 2002/96/EG über Elektro- und Elektronik-Altgeräte dürfen Elektro- und Elektronik-Altgeräte nicht mehr als kommunale Abfälle entsorgt werden. MSI hat europaweit verschiedene Sammel- und Recyclingunternehmen beauftragt, die in die Europäische Union in Verkehr gebrachten Produkte, am Ende seines Lebenszyklus zurückzunehmen. Bitte entsorgen Sie dieses Produkt zum gegebenen Zeitpunkt ausschliesslich an einer lokalen Altgerätesammelstelle in Ihrer Nähe.

FRANÇAIS

En tant qu'écologiste et afin de protéger l'environnement, MSI tient à rappeler ceci... Au sujet de la directive européenne (EU) relative aux déchets des équipement électriques et électroniques, directive 2002/96/EC, prenant effet le 13 août 2005, que les produits électriques et électroniques ne peuvent être déposés dans les décharges ou tout simplement mis à la poubelle. Les fabricants de ces équipements seront obligés de récupérer certains produits en fin de vie. MSI prendra en compte cette exigence relative au retour des produits en fin de vie au sein de la communauté européenne. Par conséquent vous pouvez retourner localement ces matériels dans les points de collecte.

РУССКИЙ

Компания MSI предпринимает активные действия по защите окружающей среды, поэтому напоминаем вам, что... В соответствии с директивой Европейского Союза (ЕС) по предотвращению загрязнения окружающей среды использованным электрическим и электронным оборудованием (директива WEEE 2002/96/ЕС), вступающей в силу 13 августа 2005 года, изделия, относящиеся к электрическому и электронному оборудованию, не могут рассматриваться как бытовой мусор, поэтому производители вышеперечисленного электронного оборудования обязаны принимать его для переработки по окончании срока службы. MSI обязуется соблюдать требования по приему продукции, проданной под маркой MSI на территории ЕС, в переработку по окончании срока службы. Вы можете вернуть эти изделия в специализированные пункты приема.

ESPAÑOL

MSI como empresa comprometida con la protección del medio ambiente, recomienda: Bajo la directiva 2002/96/EC de la Unión Europea en materia de desechos y/o equipos electrónicos, con fecha de rigor desde el 13 de agosto de 2005, los productos clasificados como "eléctricos y equipos electrónicos" no pueden ser depositados en los contenedores habituales de su municipio, los fabricantes de equipos electrónicos, están obligados a hacerse cargo de dichos productos al término de su periodo de vida. MSI estará comprometido con los términos de recogida de sus productos vendidos en la Unión Europea al final de su periodo de vida. Usted debe depositar estos productos en el punto limpio establecido por el ayuntamiento de su localidad o entregar a una empresa autorizada para la recogida de estos residuos.

NEDERLANDS

Om het milieu te beschermen, wil MSI u eraan herinneren dat... De richtlijn van de Europese Unie (EU) met betrekking tot Vervuiling van Elektrische en Electronische producten (2002/96/EC), die op 13 Augustus 2005 in zal gaan kunnen niet meer beschouwd worden als vervuiling. Fabrikanten van dit soort producten worden verplicht om producten retour te nemen aan het eind van hun levenscyclus. MSI zal overeenkomstig de richtlijn handelen voor de producten die de merknaam MSI dragen en verkocht zijn in de EU. Deze goederen kunnen geretourneerd worden op lokale inzamelingspunten.

SRPSKI

Da bi zaštitili prirodnu sredinu, i kao preduzeće koje vodi računa o okolini i prirodnoj sredini, MSI mora da vas podesti da... Po Direktivi Evropske unije ("EU") o odbačenoj elektonskoj i električnoj opremi, Direktiva 2002/96/EC, koja stupa na snagu od 13. Avgusta 2005, proizvođi koji spadaju pod "elektronsku i električnu opremu" ne mogu više biti odbačeni kao običan otpad i proizvođaci ove opreme biće prinuđeni da uzmu natrag ove proizvode na kraju njihovog uobičajenog veka trajanja. MSI će poštovati zahtev o preuzimanju ovakvih proizvoda kojima je istekao vek trajanja, koji imaju MSI oznaku i koji su prodati u EU. Ove proizvode možete vratiti na lokalnim mestima za prikupljanje.

POLSKI

Aby chronić nasze środowisko naturalne oraz jako firma dbająca o ekologię, MSI przypomina, że... Zgodnie z Dyrektywą Unii Europejskiej ("UE") dotycząca odpadów produktów elektrycznych i elektronicznych (Dyrektywa 2002/96/EC), która wchodzi w życie 13 sierpnia 2005, tzw. "produkty oraz wyposażenie elektryczne i elektroniczne" nie mogą być traktowane jako śmieci komunalne, tak więc producenci tych produktów będą zobowiązani do odbierania ich w momencie gdy produkt jest wycofywany z użycia. MSI wypetni wymagania UE, przyjmując produkty (sprzedawane na terenie Unii Europejskiej) wycofywane z użycia. Produkty MSI będzie można zwracać w wyznaczonych punktach zbiorczych.

TÜRKÇE

Çevreci özelliğiyle bilinen MSI dünyada çevreyi korumak için hatırlatır:
Avrupa Birliği (AB) Kararnamesi Elektrik ve Elektronik Malzeme Atığı, 2002/96/EC Kararnamesi altında 13 Ağustos 2005 tarihinden itibaren geçerli olmak üzere, elektrikli ve elektronik malzemeler diğer atıklar gibi çöpe atılmayacak ve bu elektronik cihazların üreticileri, cihazların kullanım süreleri bittikten sonra ürünleri geri toplamakla yükümlü olacaktır. Avrupa Birliği'ne satılan MSI markalı ürünlerin kullanım süreleri bittiğinde MSI ürünlerin geri alınması isteği ile işbirliği içerisinde olacaktır. Ürünlerinizi yerel toplama noktalarına bırakabilirsiniz.

ČESKY

Záleží nám na ochraně životního prostředí - společnost MSI upozorňuje...

Podle směrnice Evropské unie ("EU") o likvidaci elektrických a elektronických výrobků 2002/96/EC platné od 13. srpna 2005 je zakázáno likvidovat "elektrické a elektronické výrobky" v běžném komunálním odpadu a výrobci elektrických výrobků, na které se tato směrnice vztahuje, budou povinni odebírat takové výrobky zpět po skončení jejich životnosti. Společnost MSI splní požadavky na odebrání výrobků značky MSI, prodávaných v zemích EU, po skončení jejich životnosti. Tyto výrobky můžete odevzdat v místních sběrnách.

MAGYAR

Annak érdekében, hogy környezetünk megvédjük, illetve környezetvédekként fellépve az MSI emlékezteti Önt, hogy ...
Az Európai Unió [„EU”] 2005. augusztus 13-án hatályba lépő, az elektromos és elektronikus berendezések hulladékairól szóló 2002/96/EK irányelve szerint az elektromos és elektronikus berendezések többé nem kezelhetőek lakossági hulladékként, és az ilyen elektronikus berendezések gyártói kötelesek válnak az ilyen termékek visszavételére azok hasznos élettartama végén. Az MSI betartja a termékviszavétellel kapcsolatos követelményeket az MSI márkanév alatt az EU-n belül értékesített termékek esetében, azok élettartamának végén. Az ilyen termékeket a legközelebbi gyűjtőhelyre viheti.

ITALIANO

Per proteggere l'ambiente, MSI, da sempre amica della natura, ti ricorda che...
In base alla Direttiva dell'Unione Europea (EU) sullo Smaltimento dei Materiali Elettrici ed Elettronici, Direttiva 2002/96/EC in vigore dal 13 Agosto 2005, prodotti appartenenti alla categoria dei Materiali Elettrici ed Elettronici non possono più essere eliminati come rifiuti municipali: i produttori di detti materiali saranno obbligati a ritirare ogni prodotto alla fine del suo ciclo di vita. MSI si addegerà a tale Direttiva ritirando tutti i prodotti marchiati MSI che sono stati venduti all'interno dell'Unione Europea alla fine del loro ciclo di vita. È possibile portare i prodotti nel più vicino punto di raccolta

日本JIS C 0950材質宣言

日本工業規格JIS C 0950により、2006年7月1日以降に販売される特定分野の電気および電子機器について、製造者による含有物質の表示が義務付けられます。
http://www.msi.com/html/popup/csr/ceмм_jp.html
http://tw.msi.com/html/popup/csr_tw/ceмм_jp.html

India RoHS

This product complies with the "India E-waste (Management and Handling) Rule 2011" and prohibits use of lead, mercury, hexavalent chromium, polybrominated biphenyls or polybrominated diphenyl ethers in concentrations exceeding 0.1 weight % and 0.01 weight % for cadmium, except for the exemptions set in Schedule 2 of the Rule.

Türkiye EEE yönetmeliği

Türkiye Cumhuriyeti: EEE Yönetmeliğine Uygundur

Україна обмеження на наявність небезпечних речовин

Обладнання відповідає вимогам Технічного регламенту щодо обмеження використання деяких небезпечних речовин в електричному та електронному обладнанні, затвердженого постановою Кабінету Міністрів України від 3 грудня 2008 № 1057.

Việt Nam RoHS

Kể từ ngày 01/12/2012, tất cả các sản phẩm do công ty MSI sản xuất tuân thủ Thông tư số 30/2011/TT-BCT quy định tạm thời về giới hạn hàm lượng cho phép của một số hóa chất độc hại có trong các sản phẩm điện, điện tử"

Environmental Policy

- The product has been designed to enable proper reuse of parts and recycling and should not be thrown away at its end of life.
- Users should contact the local authorized point of collection for recycling and disposing of their end-of-life products.
- Visit the MSI website and locate a nearby distributor for further recycling information.
- Users may also reach us at gpcontdev@msi.com for information regarding proper Disposal, Take-back, Recycling, and Disassembly of MSI products.



产品中有害物质的名称及含量

| 部件名称 | 有害物质 | | | | | |
|--|--------|--------|--------|--------------|------------|--------------|
| | 铅 (Pb) | 汞 (Hg) | 镉 (Cd) | 六价铬 (Cr(VI)) | 多溴联苯 (PBB) | 多溴二苯醚 (PBDE) |
| 印刷电路板组件* | X | 0 | 0 | 0 | 0 | 0 |
| 电池**  | X | 0 | 0 | 0 | 0 | 0 |
| 外部信号连接头 | X | 0 | 0 | 0 | 0 | 0 |
| 线材 | X | 0 | 0 | 0 | 0 | 0 |

本表格依据 SJ/T 11364 的规定编制。

0: 表示该有害物质在该部件所有均质材料中的含量均在 GB/T 26572 规定的限量要求以下。

X: 表示该有害物质至少在该部件的某一均质材料中的含量超出 GB/T 26572 规定的限量要求, 但所有部件都符合欧盟 RoHS 要求。

* 印刷电路板组件: 包括印刷电路板及其构成的零部件。

** 电池本体上如有环保使用期限标识, 以本体标识为主。

■ 上述有毒有害物质或元素清单会依型号之部件差异而有所增减。

■ 产品部件本体上如有环保使用期限标识, 以本体标识为主。

Copyright

msi Micro-Star Int'l Co., Ltd.
Copyright © 2015 All rights reserved.

The material in this document is the intellectual property of Micro-Star Int'l Co., Ltd. We take every care in the preparation of this document, but no guarantee is given as to the correctness of its contents. Our products are under continual improvement and we reserve the right to make changes without notice.

Technical Support

If a problem arises with your system and no solution can be obtained from the user guide, please contact your place of purchase or local distributor. Alternatively, please try the following help resources for further guidance.

- Visit the MSI website for technical guide, BIOS updates, driver updates, and other information: <http://www.msi.com>
- Register your product at: <http://register.msi.com>

Trademark Recognition

All product names used in this manual are the properties of their respective owners and are acknowledged.

Revision History

Version 1.0, 2015/11, First release.